



TG.35.8113

### Specification

<b>Part No.</b>	<b>TG.35.8113</b>
<b>Product Name</b>	Apex II - Hinged TG.35 Ultra-Wideband 4G LTE Antenna
<b>Feature</b>	LTE / GSM / CDMA / DCS / PCS / WCDMA / UMTS / HSDPA / GPRS / EDGE / GPS / Wi-Fi 224mm * 58mm 698MHz to 960MHz, 1575.42MHz 1710MHz to 2700Mhz 5150MHz to 5850MHz Dipole Swivel Terminal Antenna Hinged 90° termination with SMA(M) Connector RoHS Compliant



## 1. Introduction

The hinged Apex II TG.35 Ultra-Wideband Dipole Antenna has been designed to cover all Cellular, ISM and Wi-Fi working frequencies in the 700-6000 MHz spectrum. It has the highest wide-band efficiency in its range of any terminal antenna on the market today.

The Apex II has been primarily designed for use with 4G LTE modules and devices that require the highest possible efficiency and peak gain to deliver best in class throughput on all major cellular (2G/3G/4G) bands worldwide for access points, terminals and routers. Vital for applications such as high speed video and real-time streaming, or high capacity MIMO networks on public transportation.

The antenna is a ground plane independent antenna, meaning it does not need to be connected to the ground-plane of a device to radiate efficiently, on the other hand neither is it seriously detuned by connecting to a ground-plane, thus avoiding a problem notorious to smaller antennas.

It comes with a SMA (M) connector and swivel mechanism that allows the antenna part to be rotated to fit in tight environments.

The Apex II exhibits high efficiency and is backward compatible with 2G and 3G cellular applications such as GSM, LTE, UMTS, WI-FI and even has GPS included for Assisted GPS and/or E911 applications.

It is an ideal solution for any device requiring high, reliable performance. It is also guaranteed to meet any type approval or carrier certification requirements from an efficiency standpoint. The antenna also makes an excellent reference antenna for test purposes. It has been designed as an omni-directional antenna and the radiation patterns show this and are stable across all bands.

## 2. Specifications

ELECTRICAL								
Standard		LTE/GSM/CDMA 700/850/900	GPS/GLONASS	LTE/GSM/HSPA/CD MA 700/1800/1900	UMTS/HSPA 2100	Wi-Fi 2400	LTE 2600	Wi-Fi 5800
Frequency (MHz)		698~960	1565~1612	1710~1990	1920~2170	2400~2500	2500~2700	4800~6000
EFFICIENCY (%)								
In free space	Straight	53.92	55.66	64.44	62.55	49.61	53.14	56.35
	Bent	56.51	55.19	68.87	68.72	53.41	54.11	55.84
On 150*90mm ground plane edge	Straight	84.72	66.85	71.00	71.43	56.21	52.22	51.59
	Bent	80.92	71.38	71.62	71.14	52.81	53.28	51.82
On 30*30cm ground plane center	Straight	59.06	51.56	62.34	61.21	67.43	53.51	51.25
	Bent	57.15	36.67	52.88	57.70	60.70	58.10	56.74
On 30*30cm ground plane edge	Straight	59.62	48.19	65.51	64.78	63.28	56.84	56.30
	Bent	53.18	41.91	63.43	62.24	62.99	46.66	47.09
AVERAGE GAIN (dBi)								
In free space	Straight	-2.71	-2.55	-1.91	-2.05	-3.05	-2.76	-2.59
	Bent	-2.50	-2.61	-1.63	-1.64	-2.72	-2.67	-2.63
On 150*90mm ground plane edge	Straight	-0.74	-1.75	-1.50	-1.46	-2.50	-2.82	-2.92
	Bent	-0.96	-1.46	-1.45	-1.48	-2.77	-2.74	-2.89
On 30*30cm ground plane center	Straight	-2.31	-2.88	-2.06	-2.13	-1.74	-2.72	-2.94
	Bent	-2.44	-4.36	-2.78	-2.40	-2.18	-2.37	-2.52
On 30*30cm ground plane edge	Straight	-2.26	-3.17	-1.85	-1.89	-2.01	-2.45	-2.58
	Bent	-2.81	-3.78	-1.99	-2.08	-2.02	-3.32	-3.37
PEAK GAIN (dBi)								
In free space	Straight	4.42	1.59	3.15	2.70	4.93	4.43	2.55
	Bent	3.16	1.64	3.37	3.34	3.28	3.06	2.09
On 150*90mm ground plane edge	Straight	3.28	3.70	4.79	5.02	2.50	2.36	2.67
	Bent	2.77	3.24	4.07	4.35	4.47	3.80	2.68
On 30*30cm ground plane center	Straight	6.37	0.75	3.34	3.39	6.44	6.92	5.29
	Bent	6.47	5.12	6.27	6.44	5.78	8.14	6.05
On 30*30cm ground plane edge	Straight	4.87	1.70	3.62	4.01	4.63	6.02	4.87
	Bent	4.78	4.07	5.95	5.45	5.87	3.89	4.59
Impedance						50Ω		
Polarization						Linear		
Radiation Pattern						Omni		
Input Power						5 W		
MECHANICAL								
Casing				UV Resistant PC/ABS				
Connector				SMA Male Hinged 90°				
Weight				75g				
Recommended Torque for Mounting				0.9 N•m				
Max torque for Mounting				1.176 N•m				
ENVIRONMENTAL								
Temperature Range				-40°C to 85°C				
Humidity				Non-condensing 65°C 95% RH				

\*Note : Product is not suitable for vibrating environment

### 3. Antenna Characteristics

#### 3.1 Testing setup

In free space

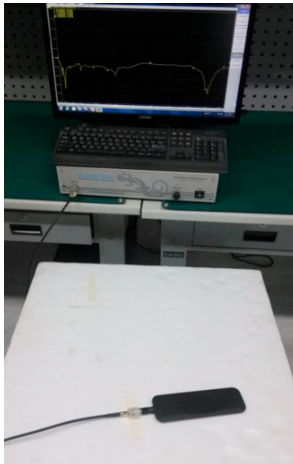

Antenna straight

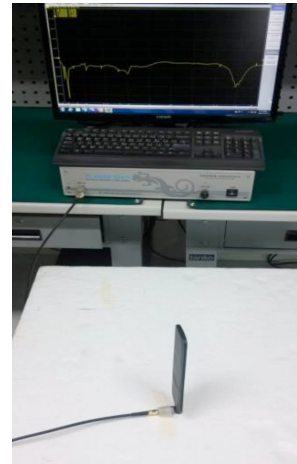

Antenna bent 90°

On 150\*90mm ground plane edge

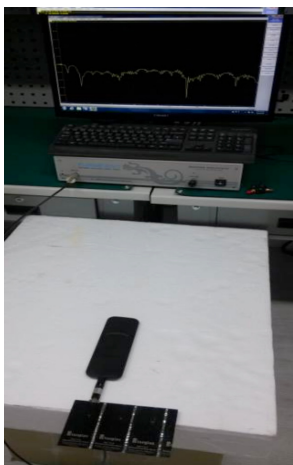

Antenna straight

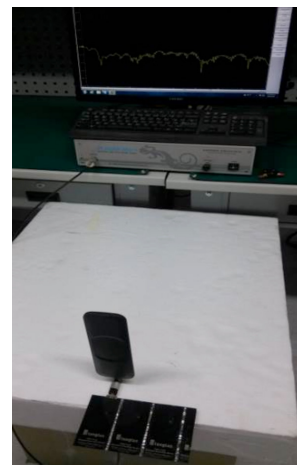

Antenna bent 90°

On 30cm\*30cm ground plane center

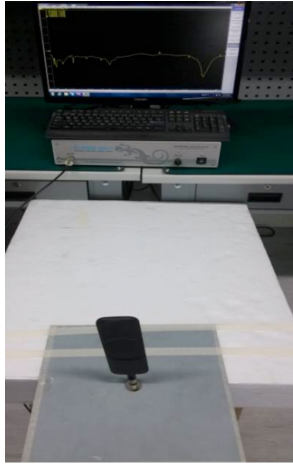

Antenna straight



Antenna bent 90°

On 30cm\*30cm ground plane edge

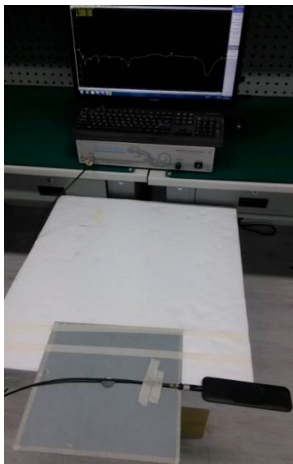

Antenna straight



Antenna bent 90°

### 3.2 Return Loss

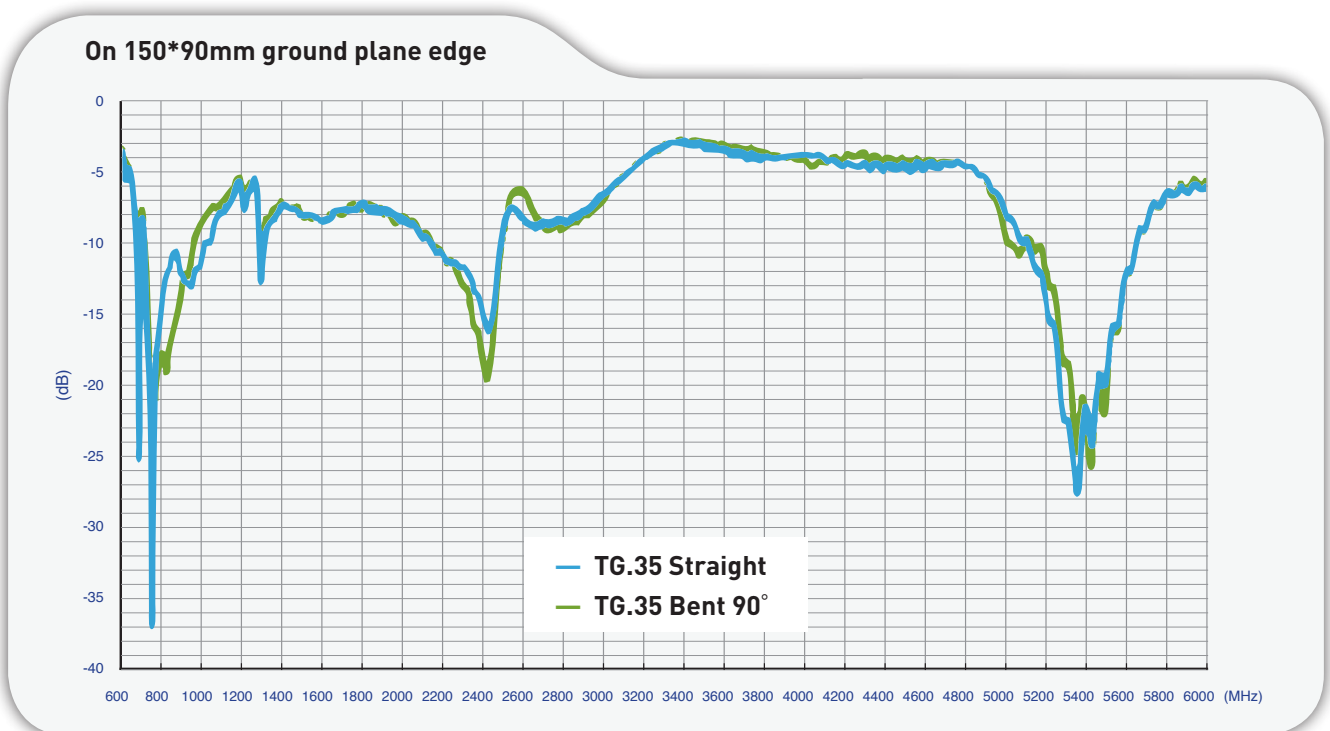
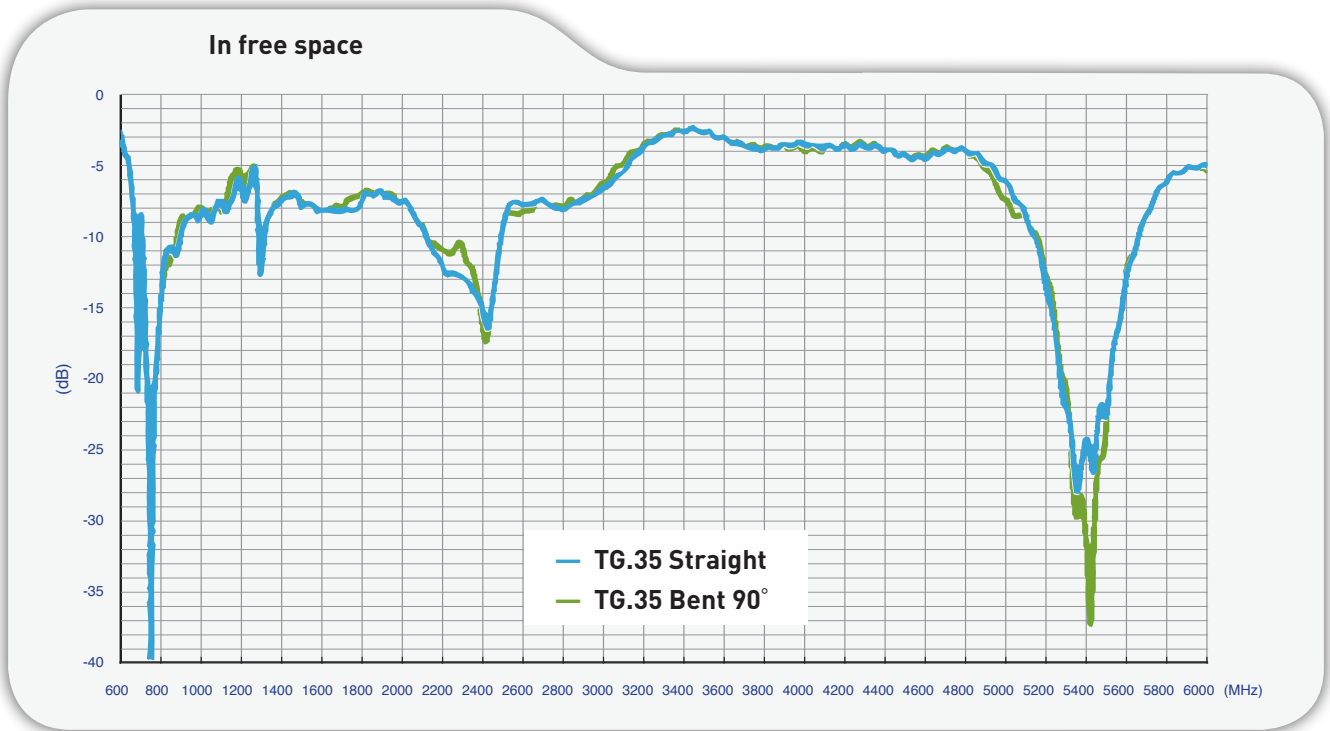

**On 30cm\*30cm ground plane center**

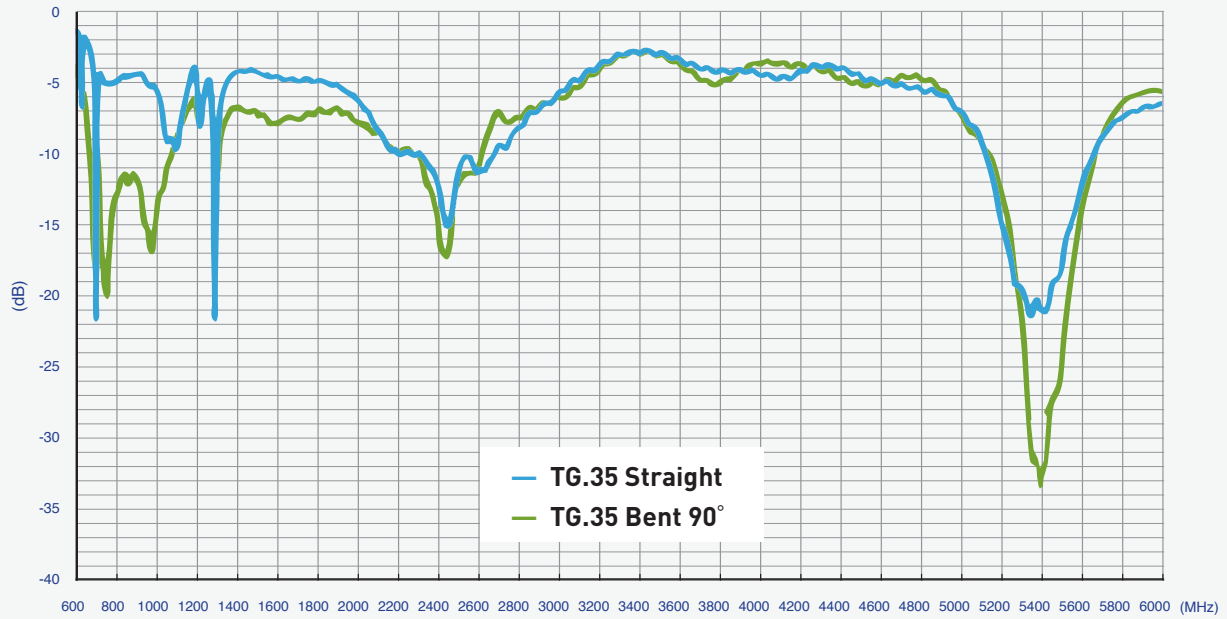

**On 30cm\*30cm ground plane edge**

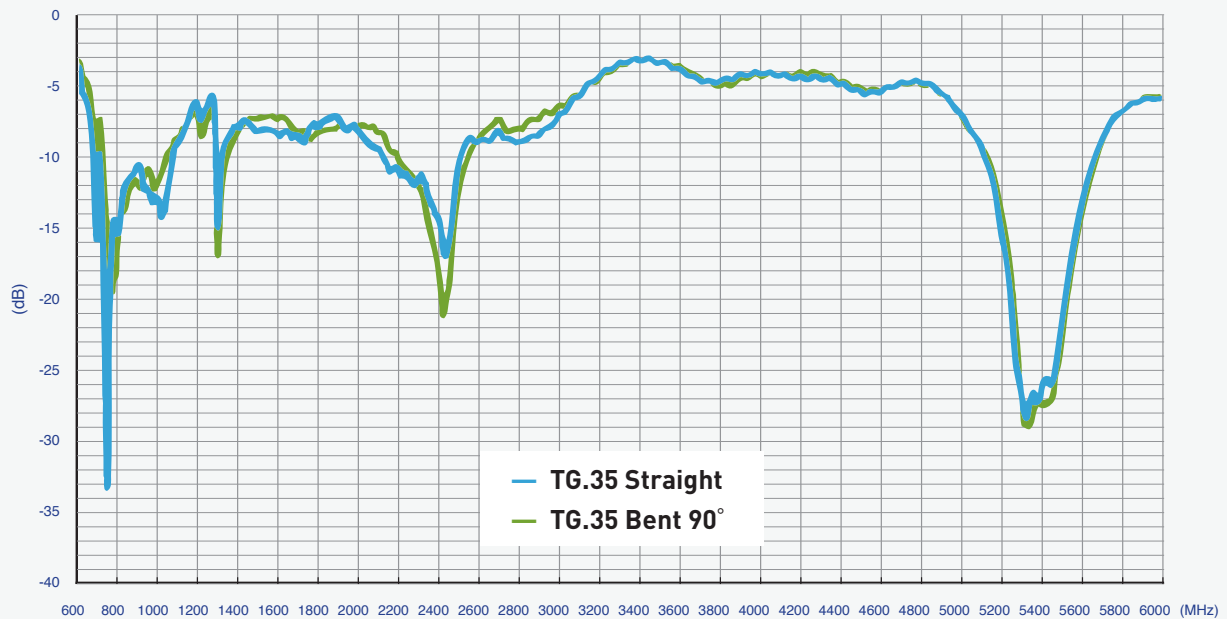

### 3.3 Peak Gain

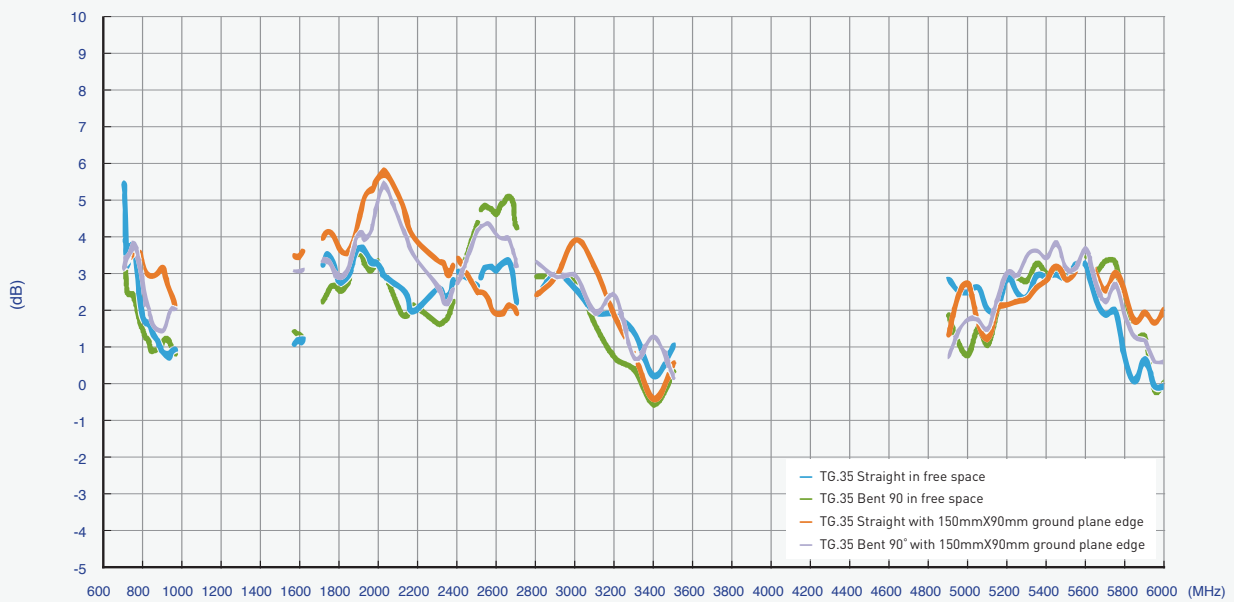
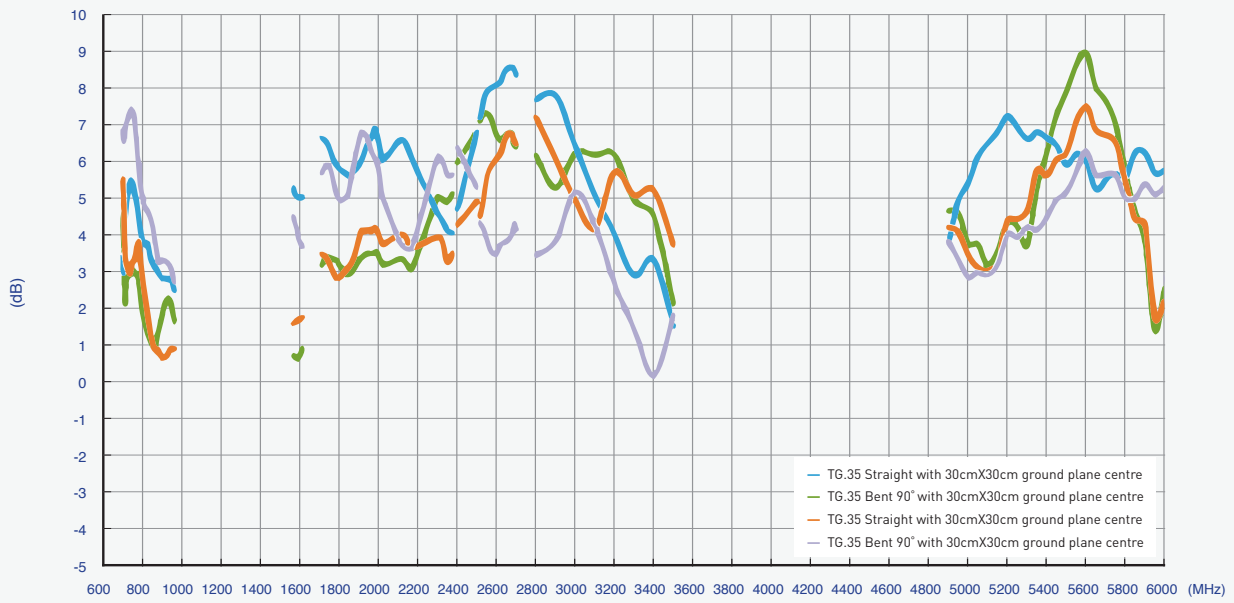



### 3.4 Efficiency

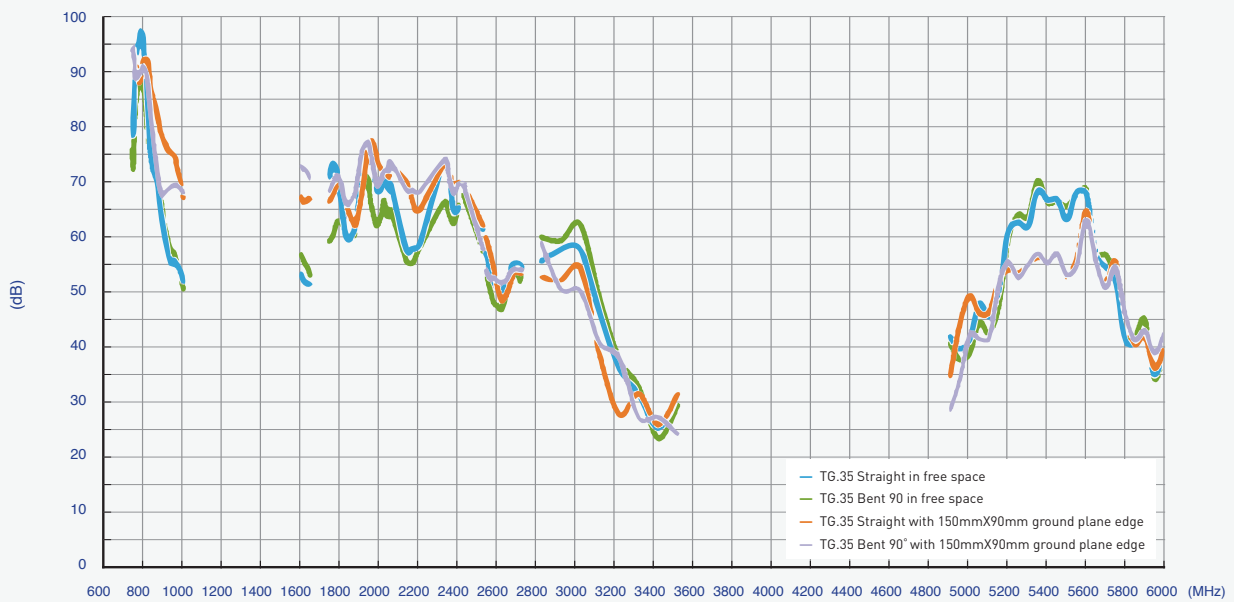
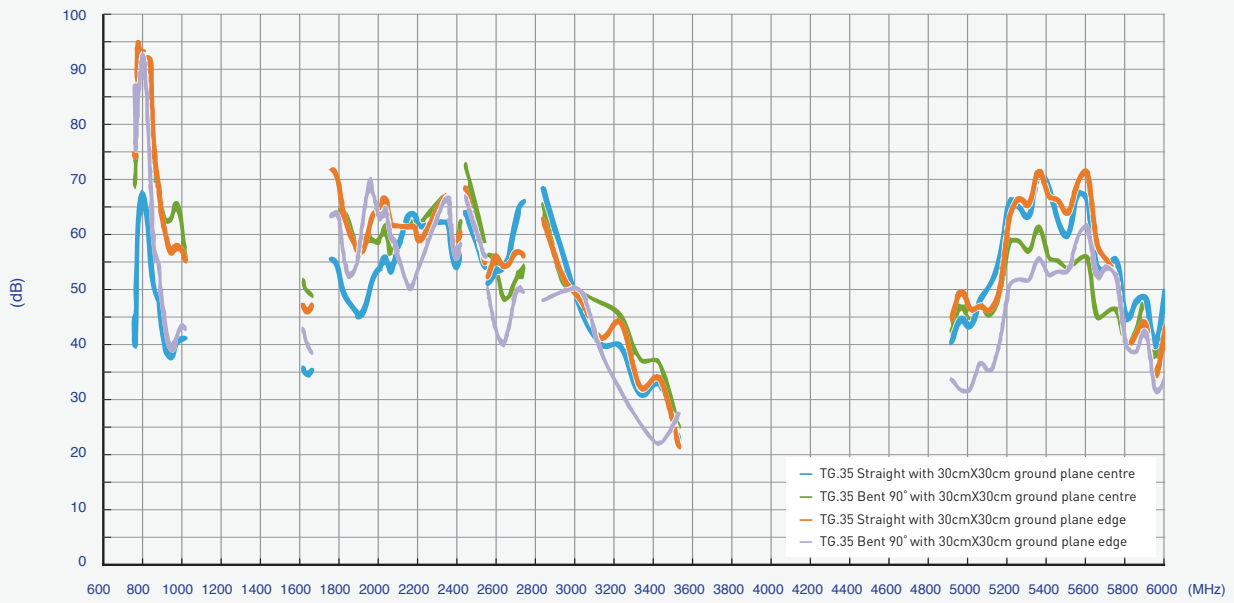

### 3.5 Average Gain

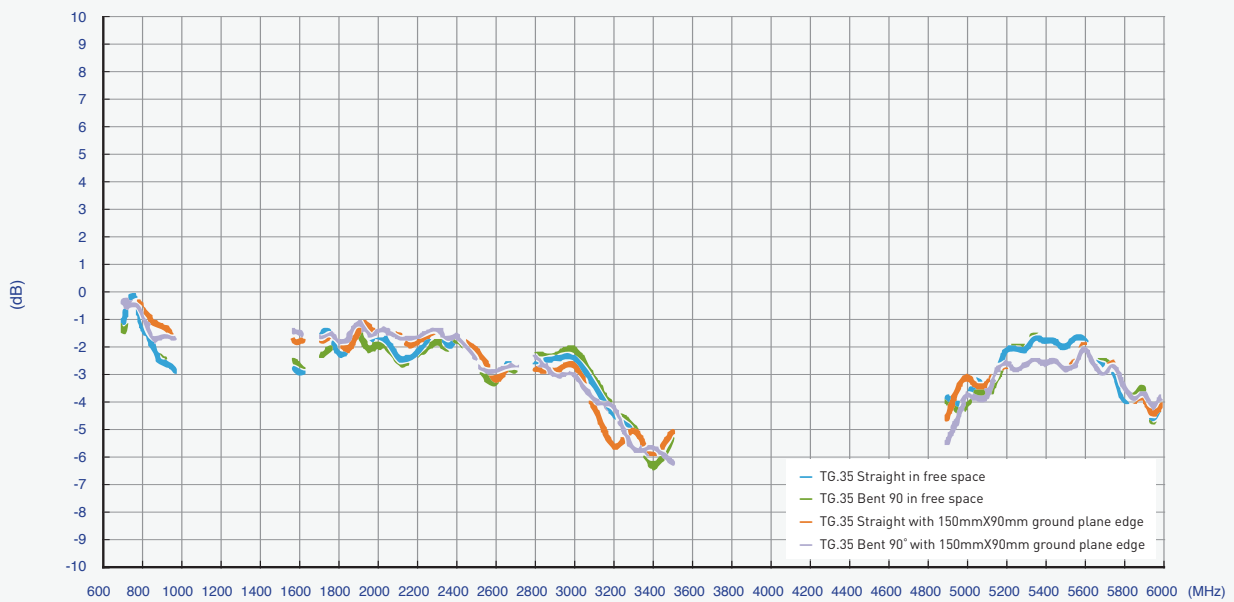
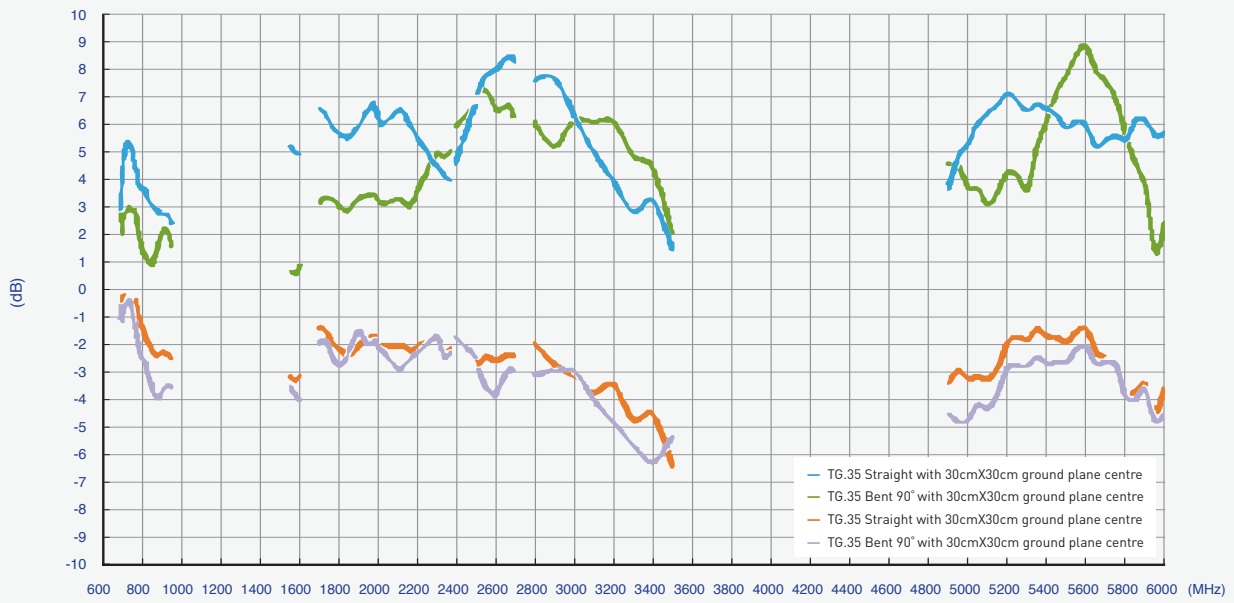

## 4. Antenna Radiation Patterns

### 4.1 Antenna setup - Antenna straight in the free space

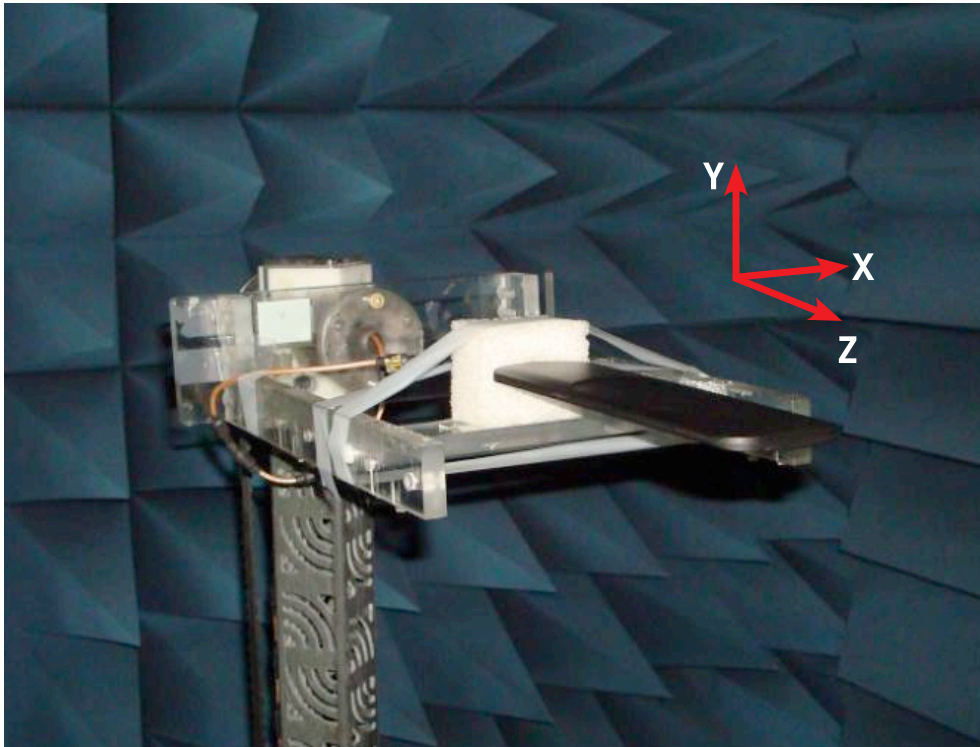

## 4.2 Antenna radiation patterns

### 4.2.1 Antenna straight in free space

#### XY Plane

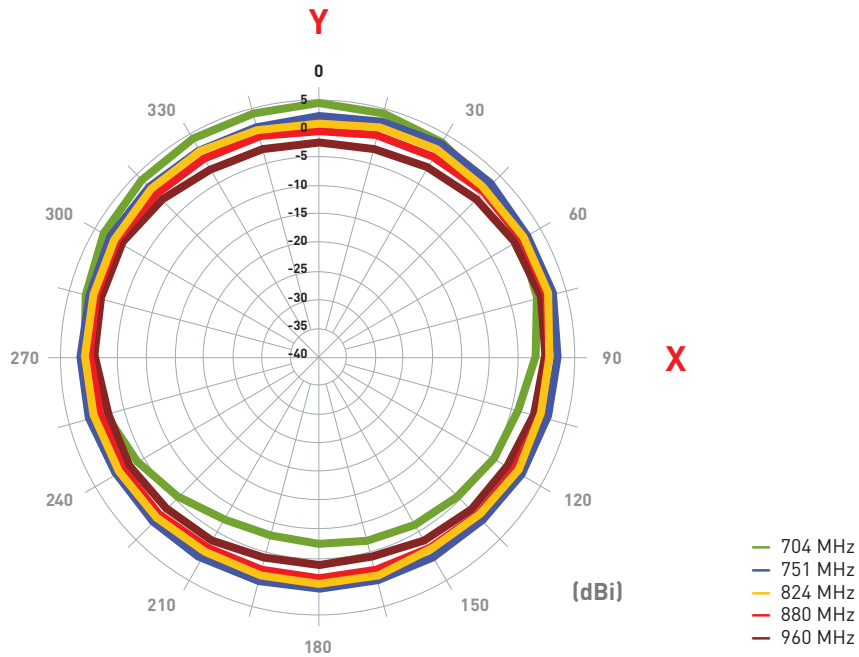

#### XZ Plane

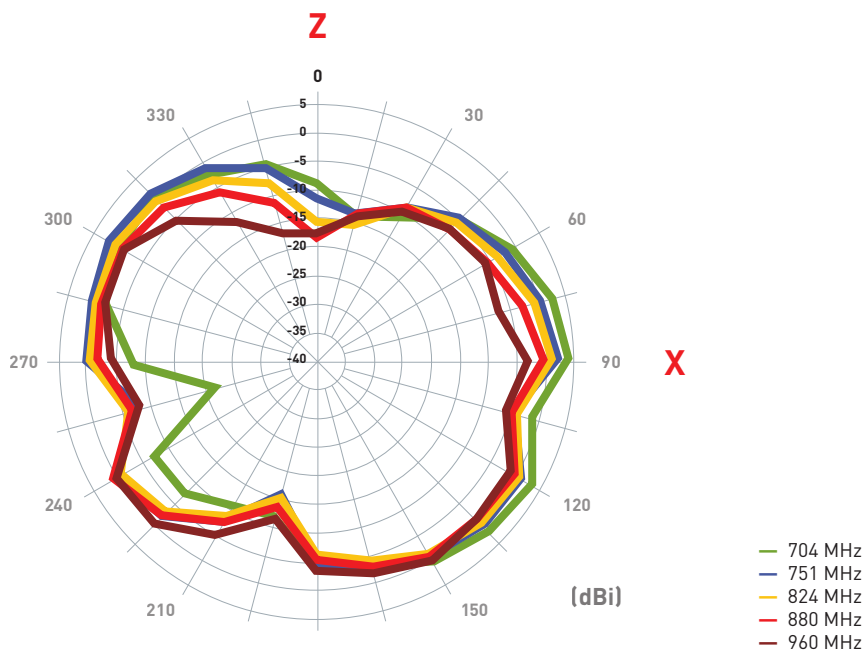

### 4.2.1 Antenna straight in free space

#### YZ Plane

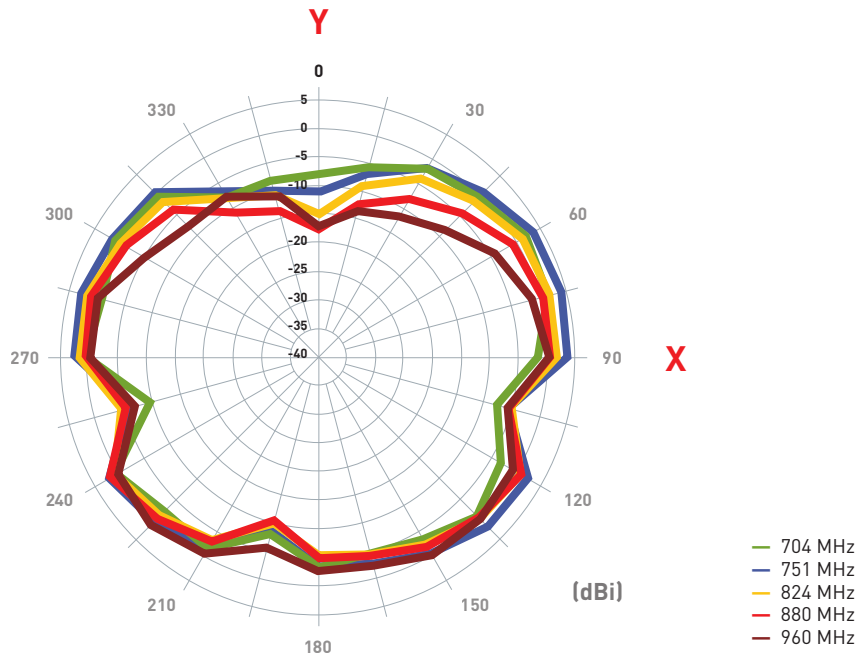

#### XY Plane

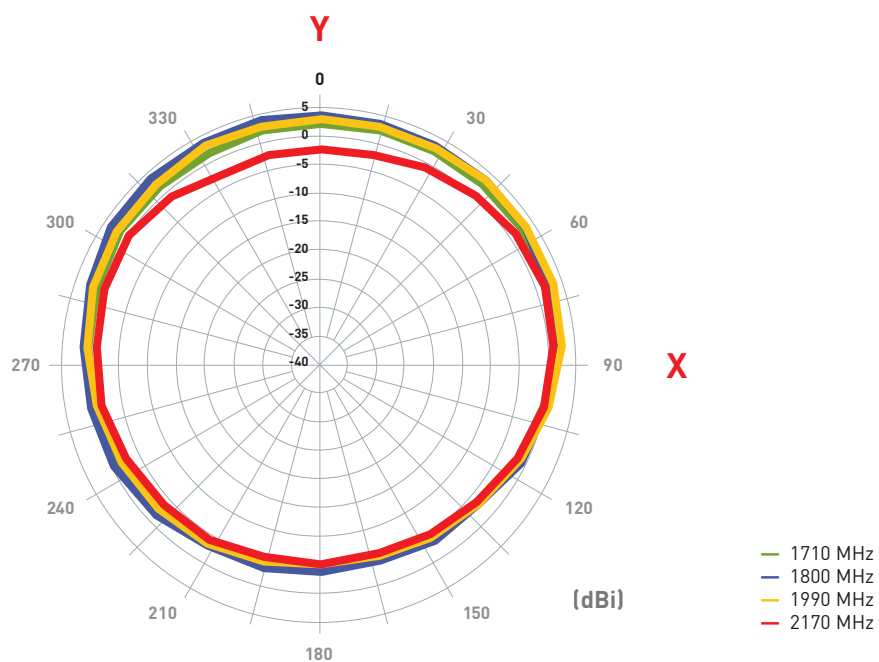

### 4.2.1 Antenna straight in free space

#### XZ Plane

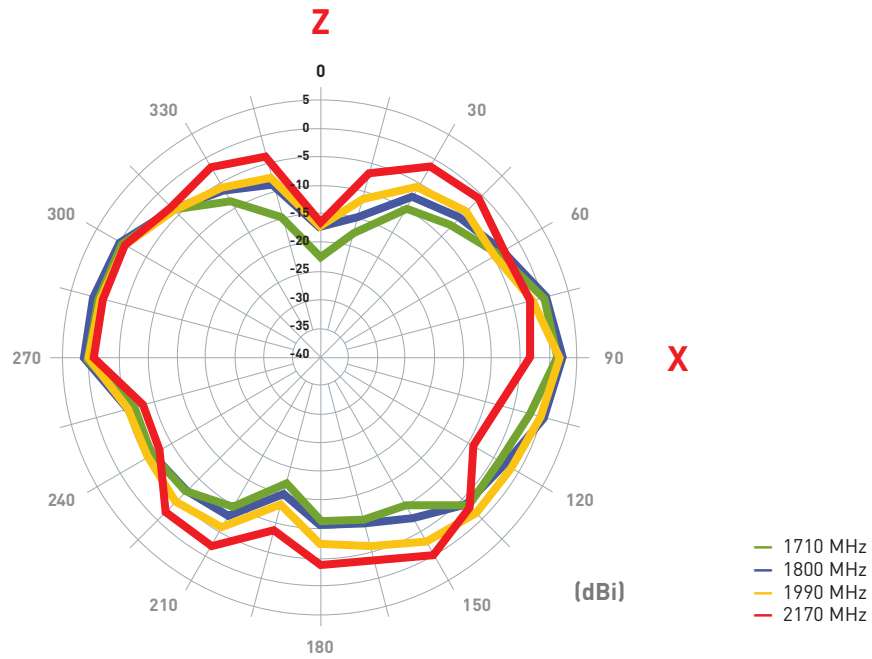

#### YZ Plane

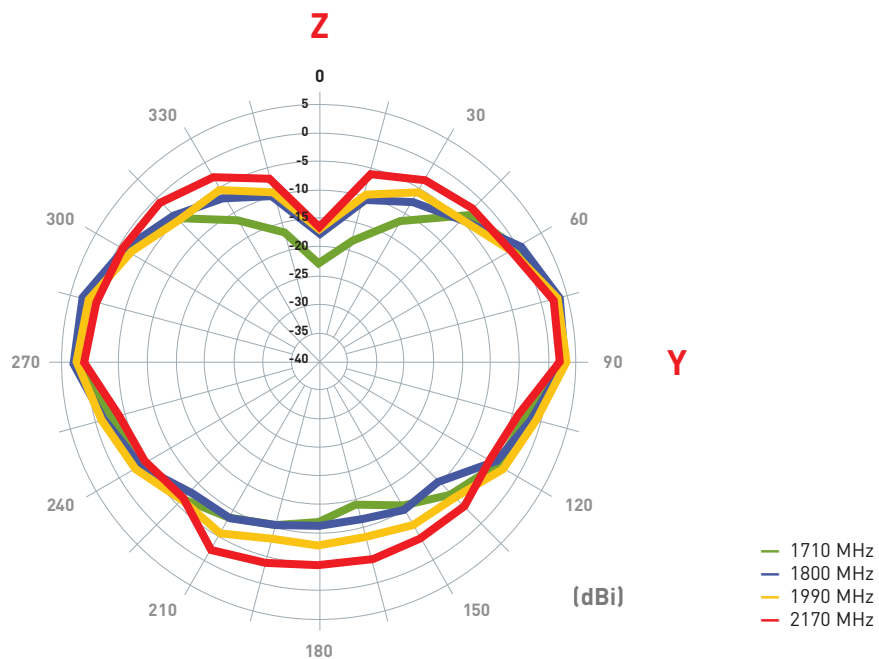

### 4.2.1 Antenna straight in free space

#### XY Plane

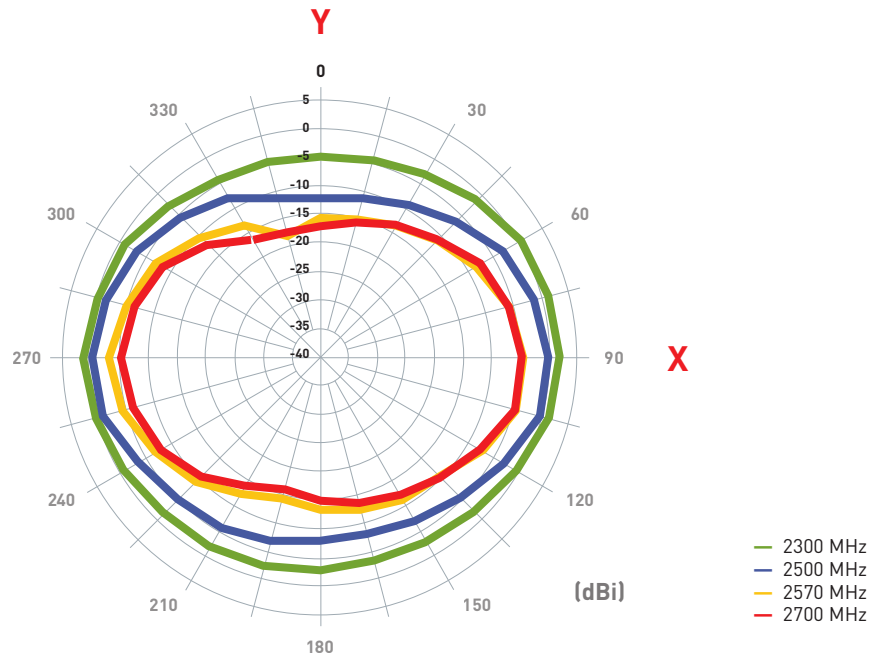

#### XZ Plane

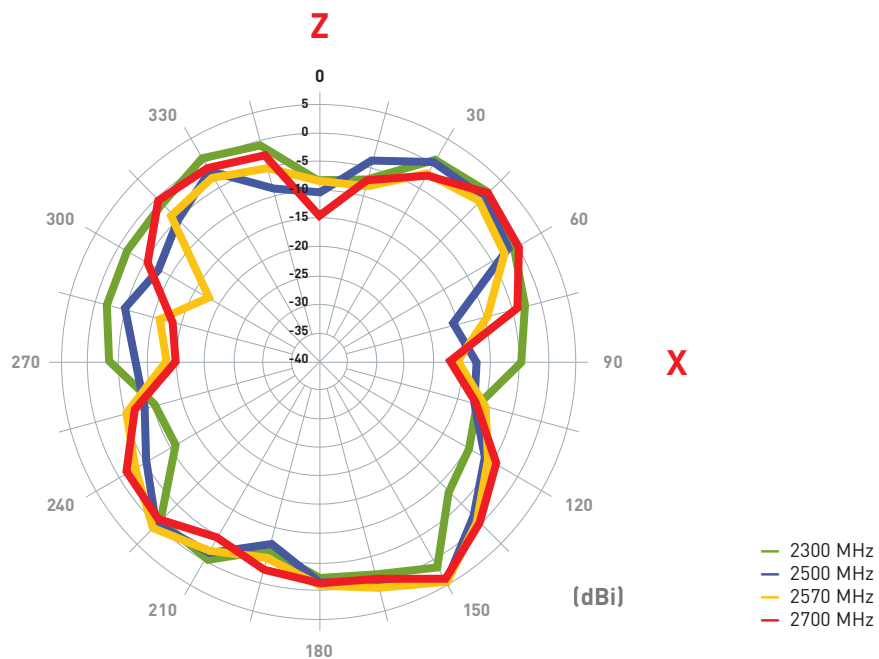

### 4.2.1 Antenna straight in free space

#### YZ Plane

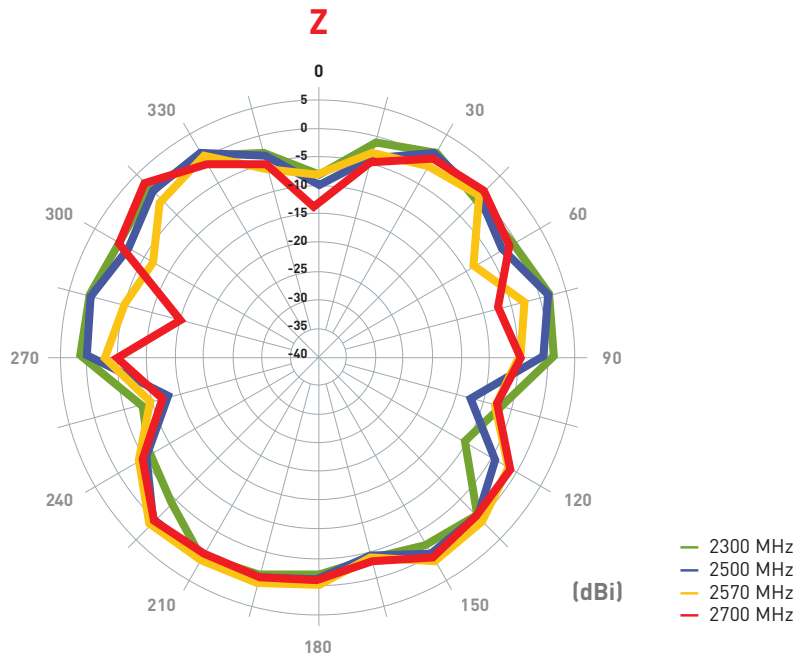

#### XY Plane

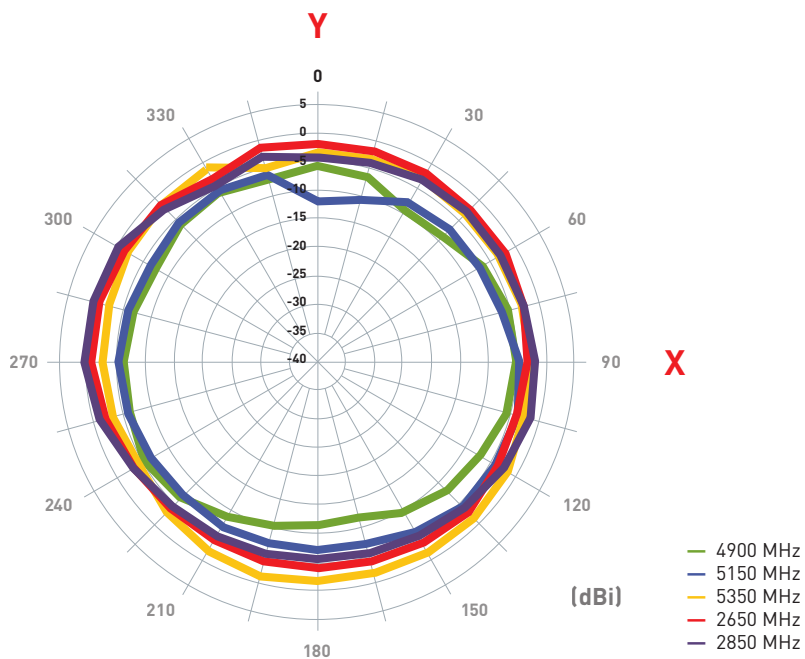



### 4.2.1 Antenna straight in free space

#### XZ Plane

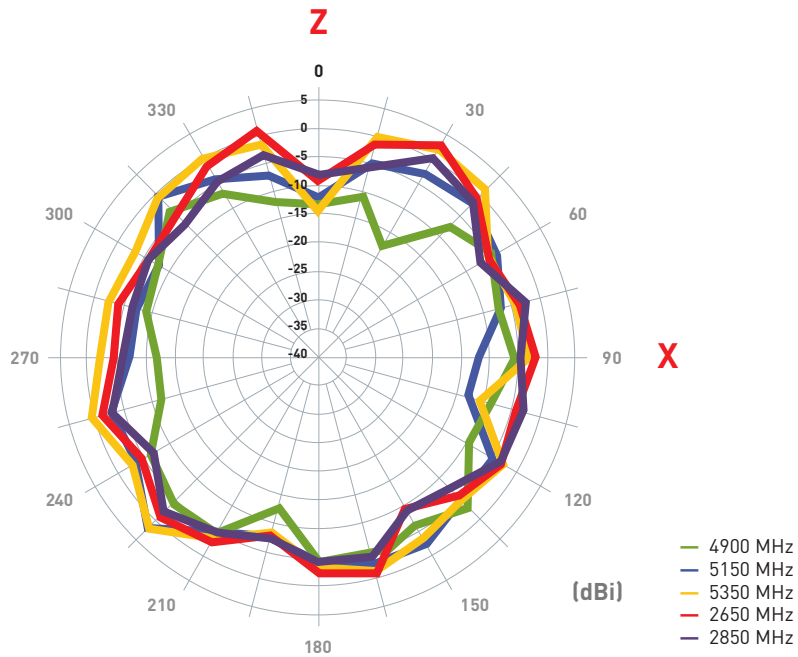

#### YZ Plane

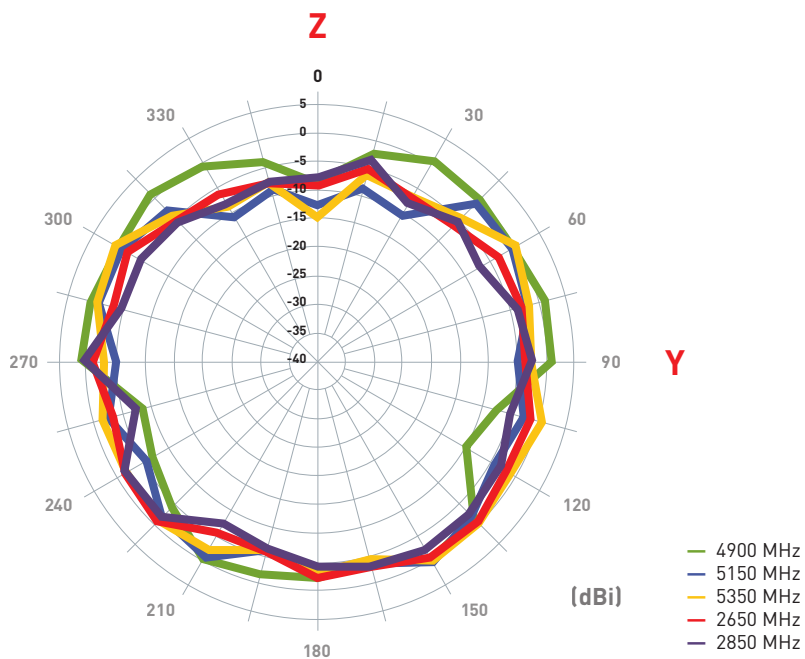

### 4.3 Antenna bent 90° in free space

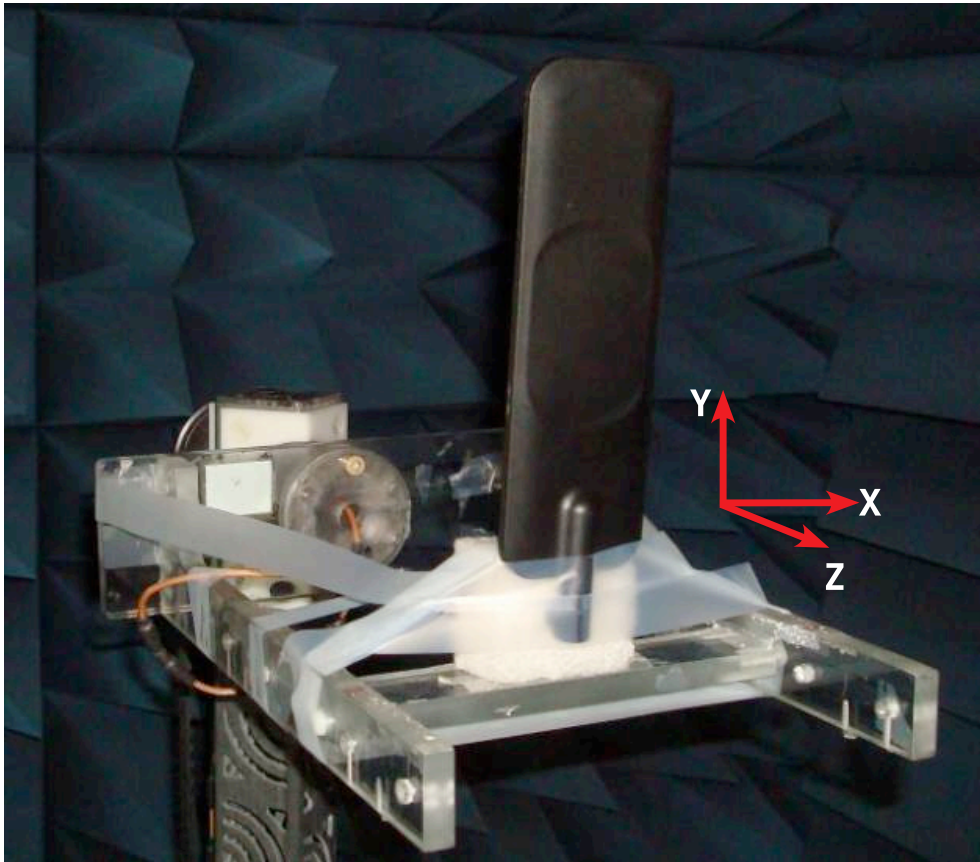

## 4.4 Antenna radiation patterns

### 4.4.1 Antenna bent 90 in free space

#### XY Plane

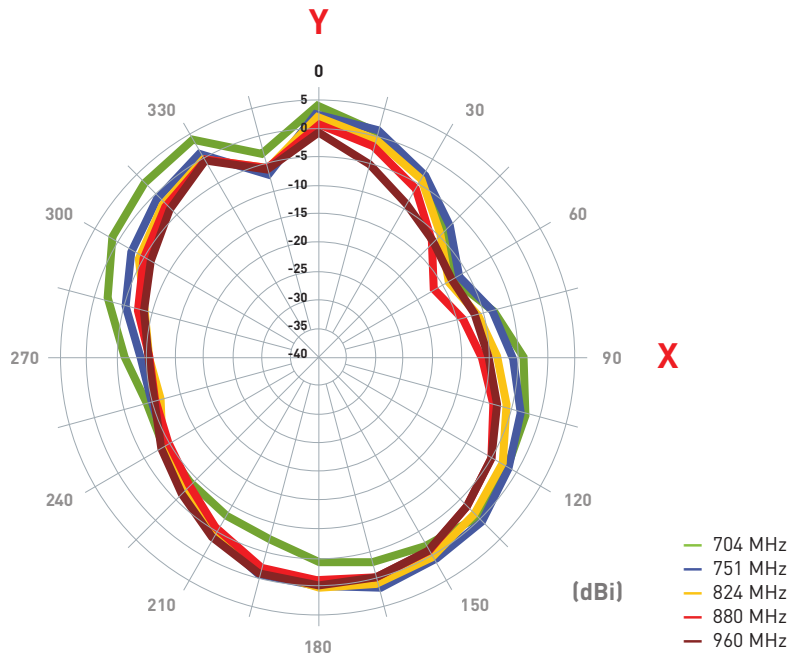

#### XZ Plane

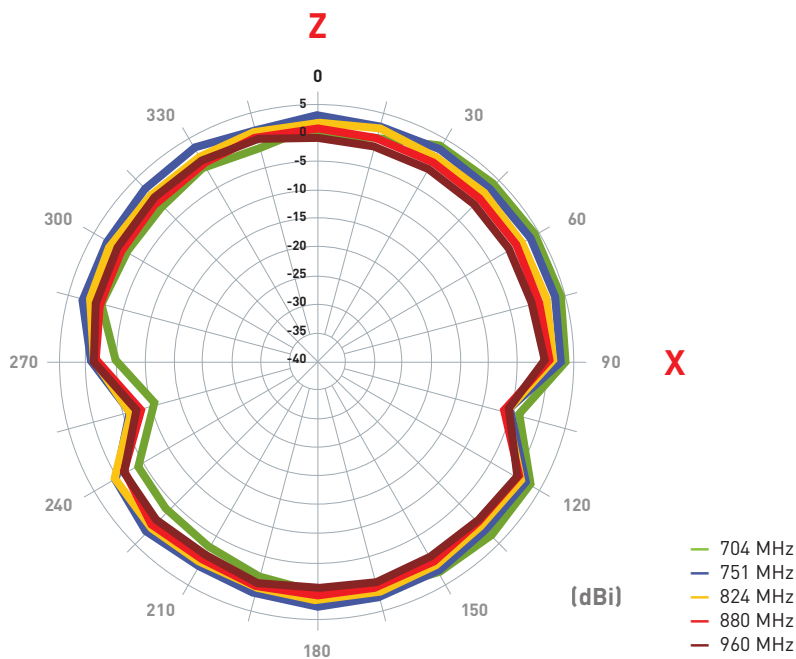

### 4.4.1 Antenna bent 90 in free space

#### YZ Plane

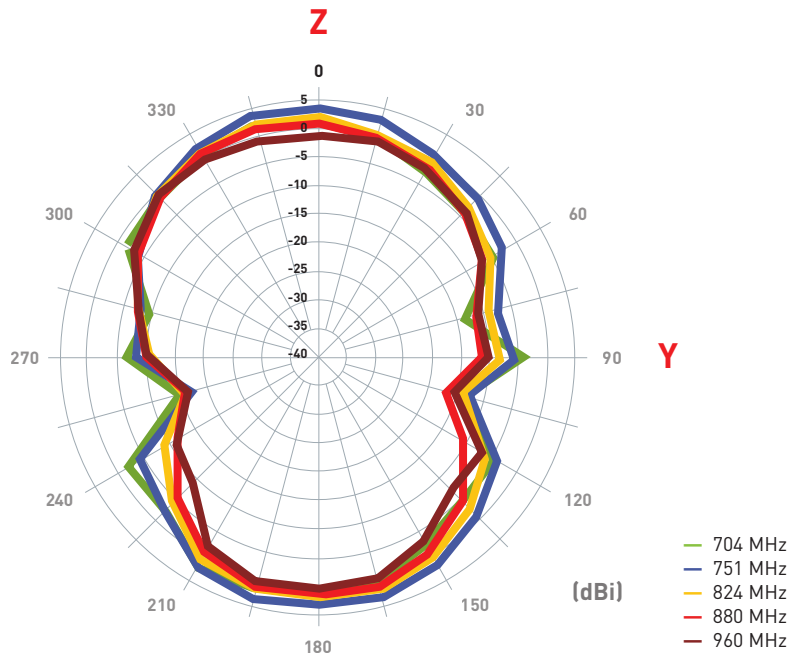

#### XY Plane

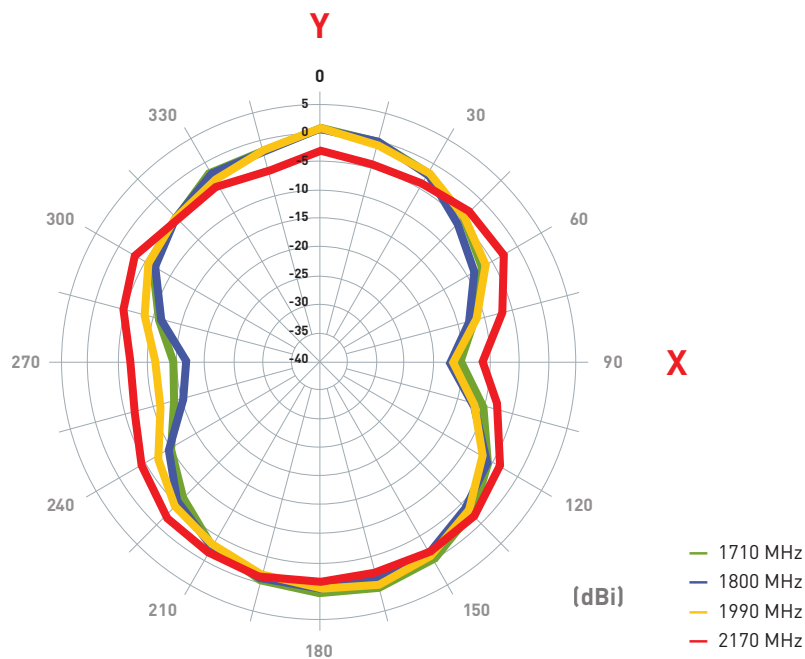

### 4.4.1 Antenna bent 90 in free space

#### XZ Plane

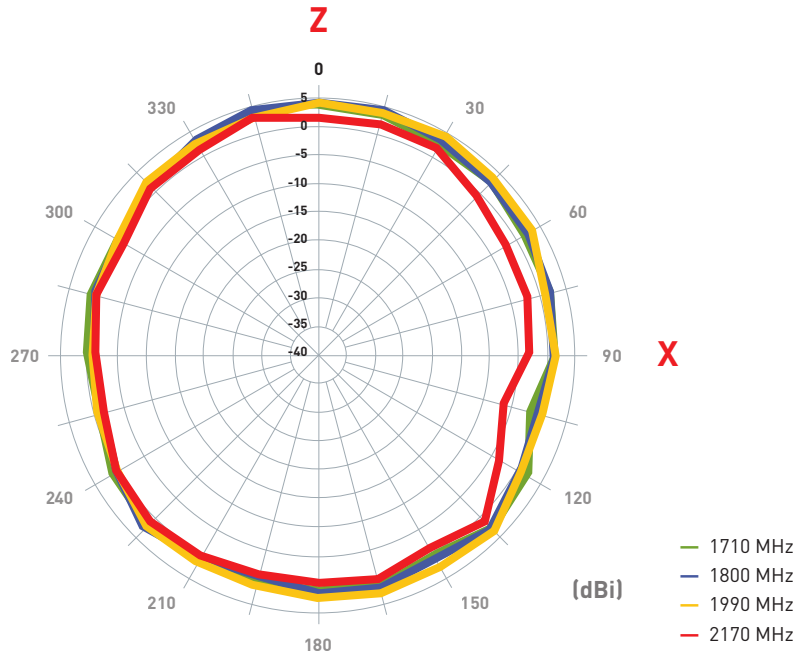

#### YZ Plane

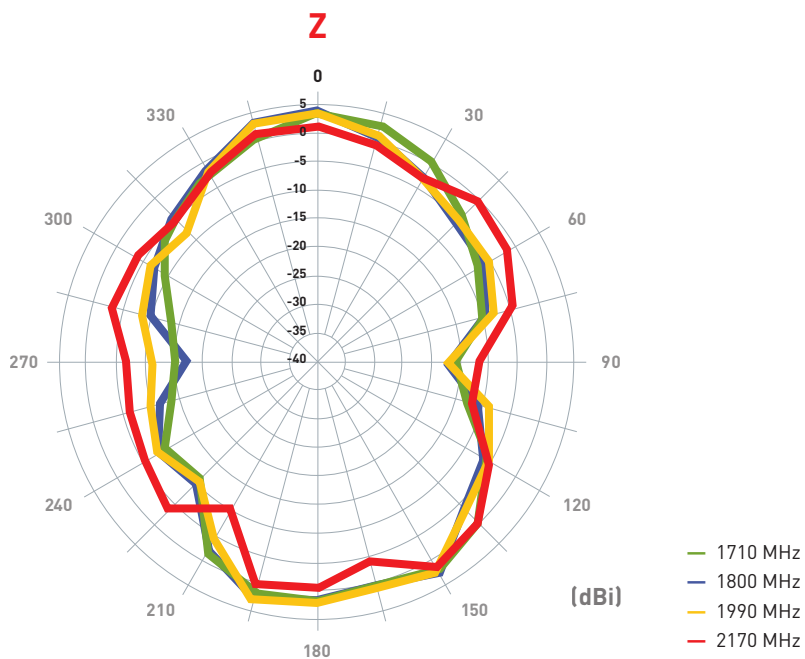

### 4.4.1 Antenna bent 90 in free space

#### XY Plane

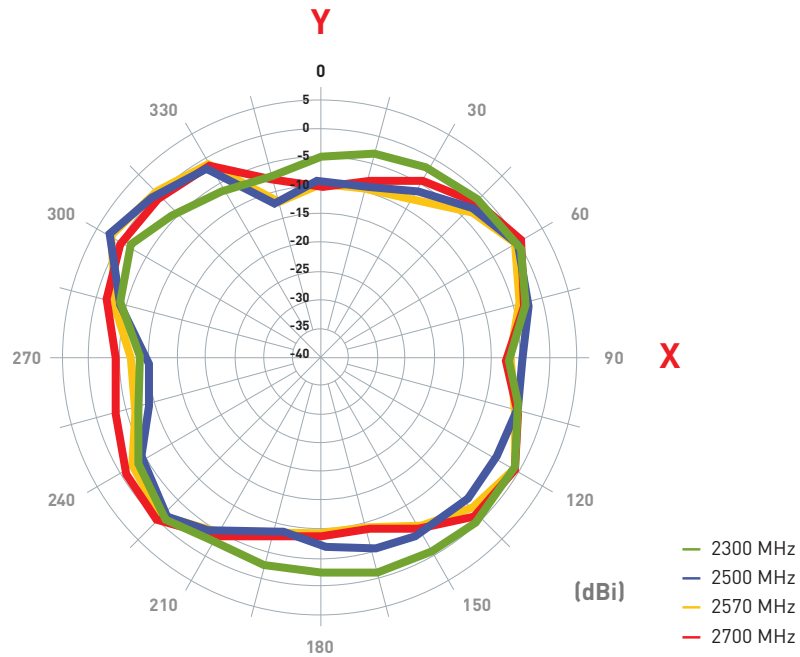

#### XZ Plane

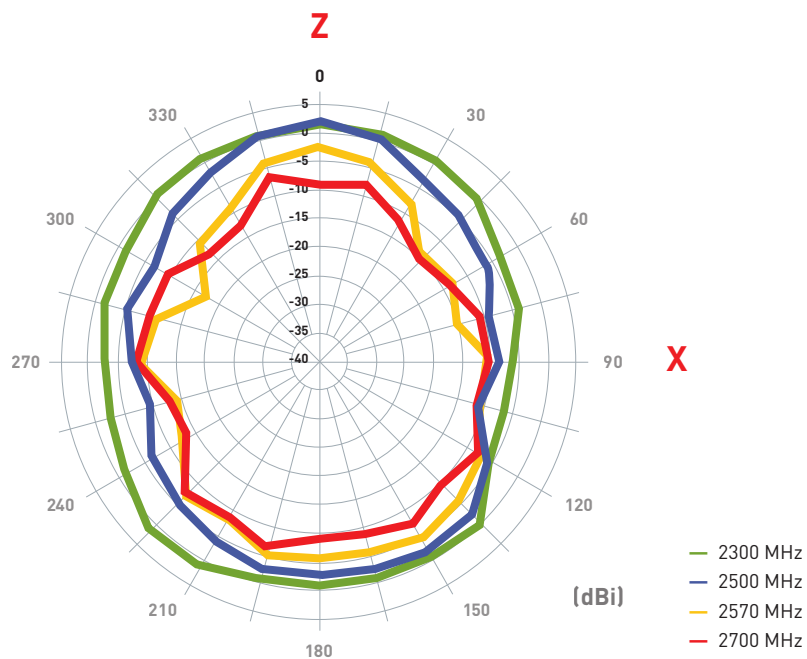

### 4.4.1 Antenna bent 90 in free space

#### YZ Plane

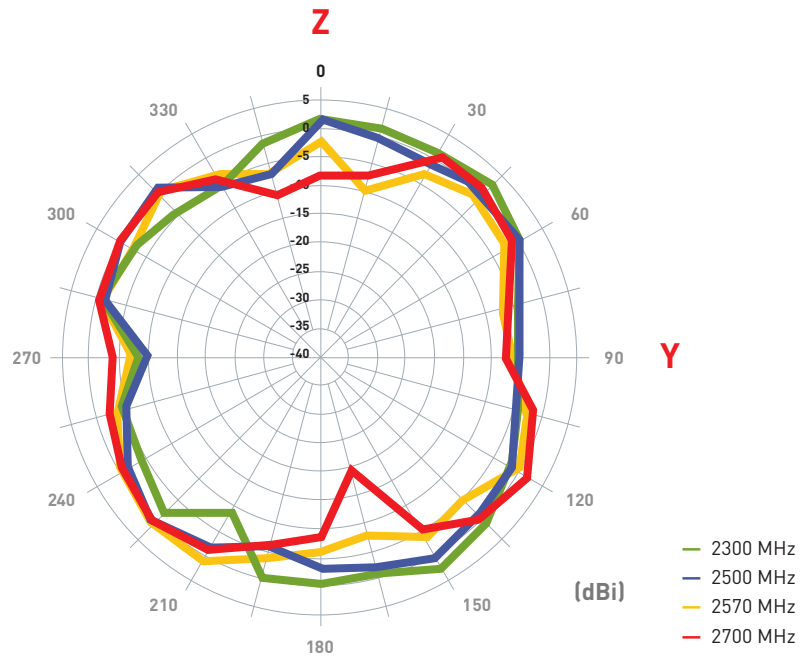

#### XY Plane

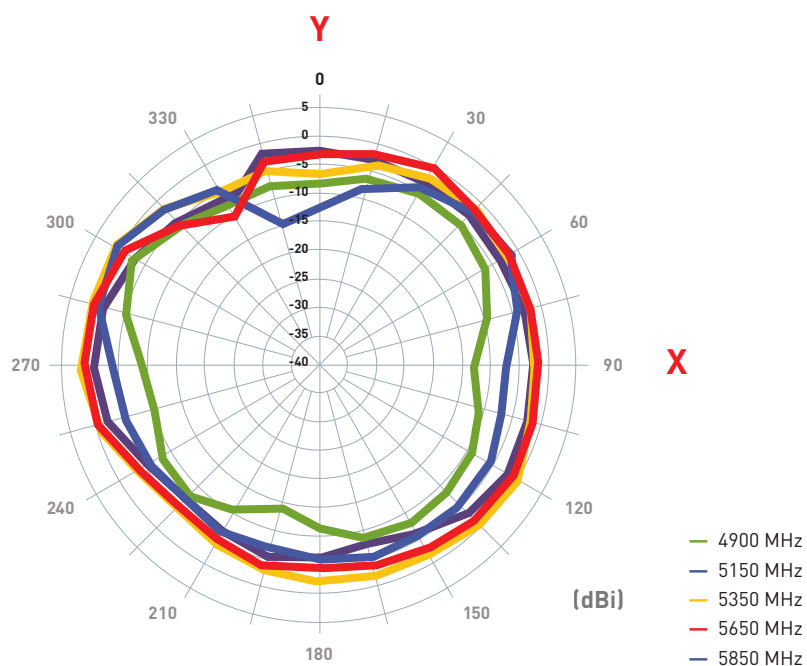

### 4.4.1 Antenna bent 90 in free space

#### XZ Plane

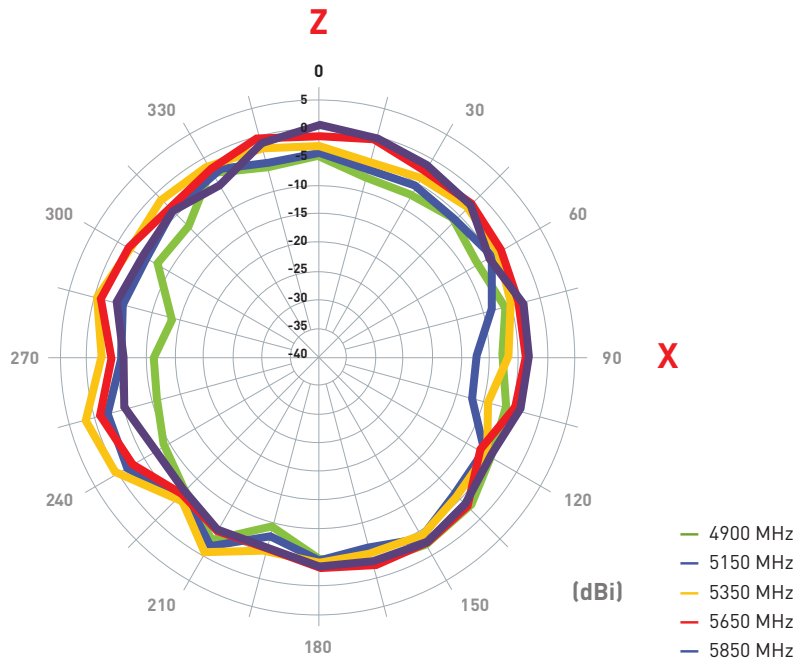

#### YZ Plane

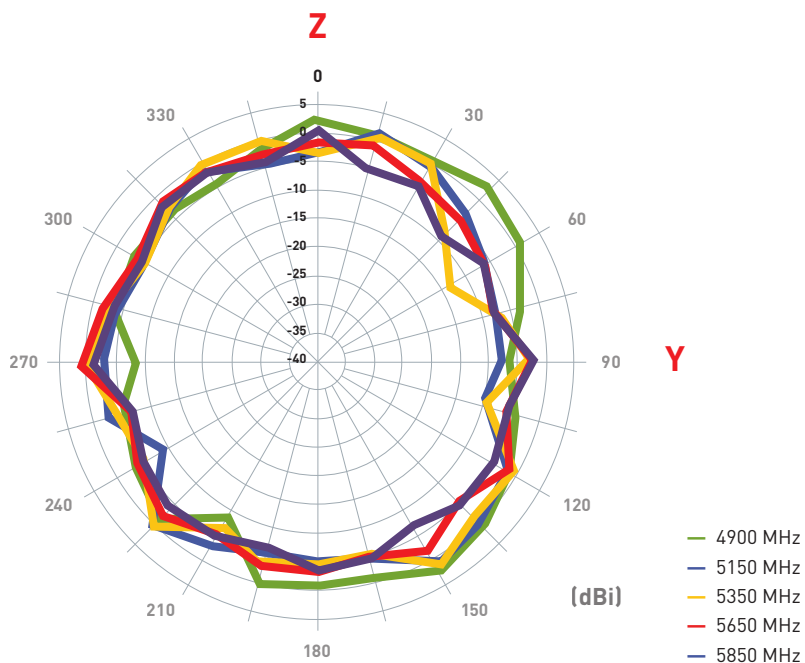



#### 4.5 Antenna setup - Antenna bent 90 with 90mmx150mm ground plane

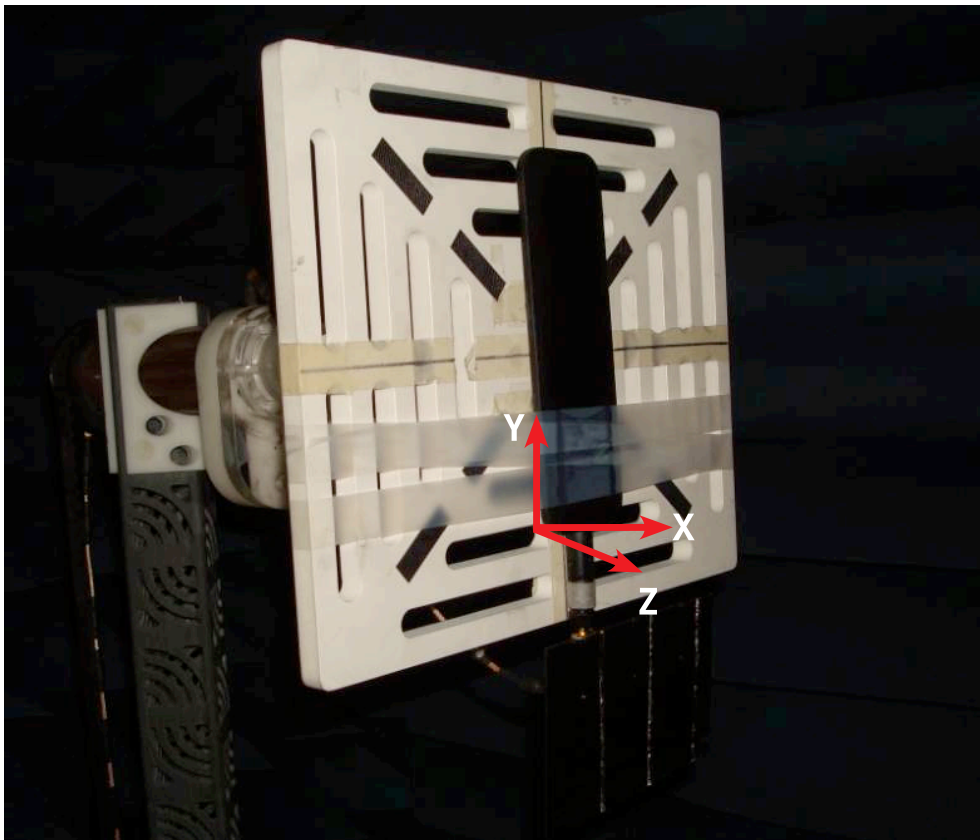

## 4.6 Antenna radiation patterns

### 4.6.1 Antenna bent 90 with 90mmx150mm ground plane

#### XY Plane

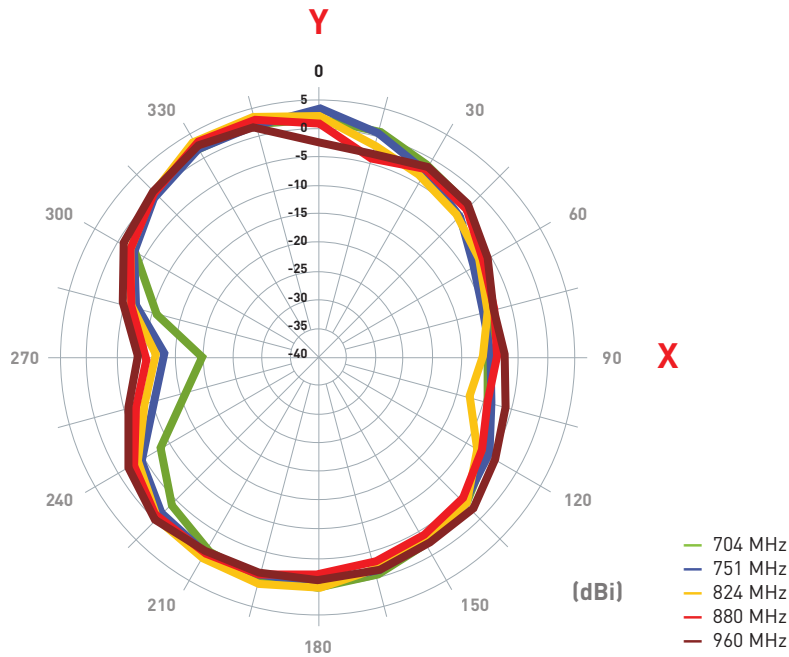

#### XZ Plane

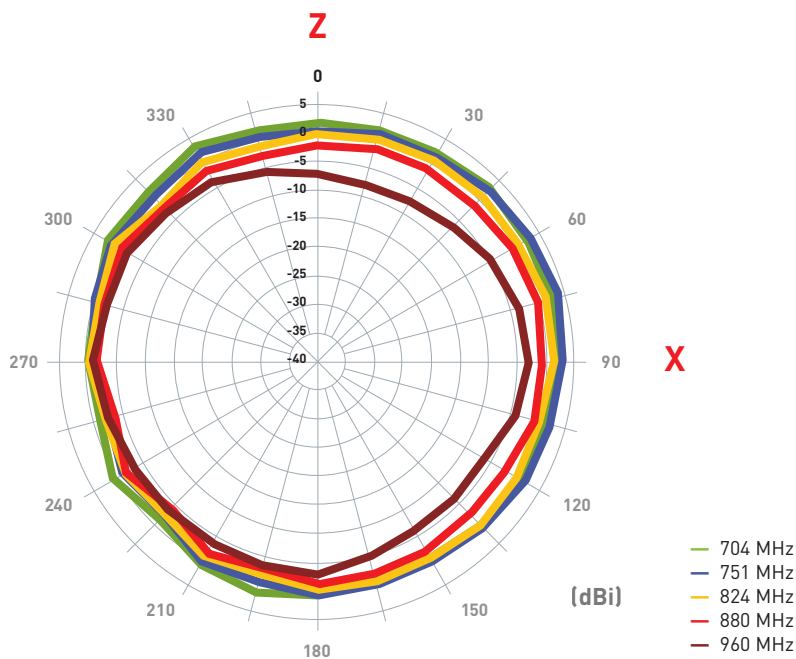

### 4.6.1 Antenna bent 90 with 90mmx150mm ground plane

#### YZ Plane

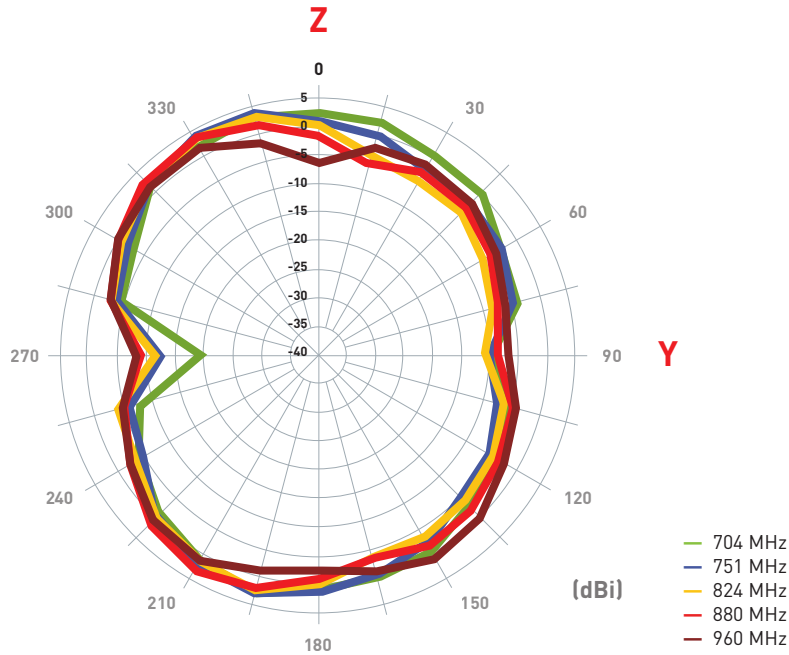

#### XY Plane

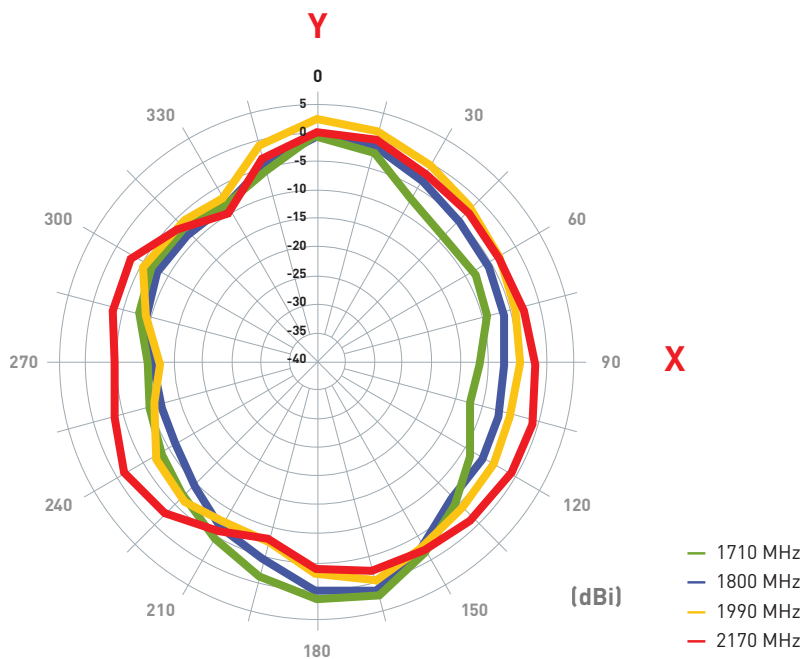

### 4.6.1 Antenna bent 90 with 90mmx150mm ground plane

#### XZ Plane

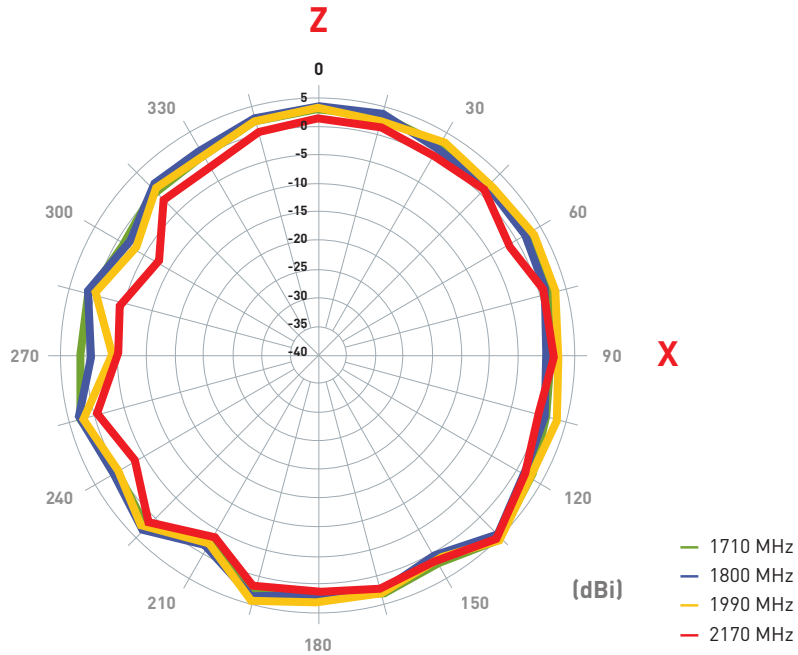

#### YZ Plane

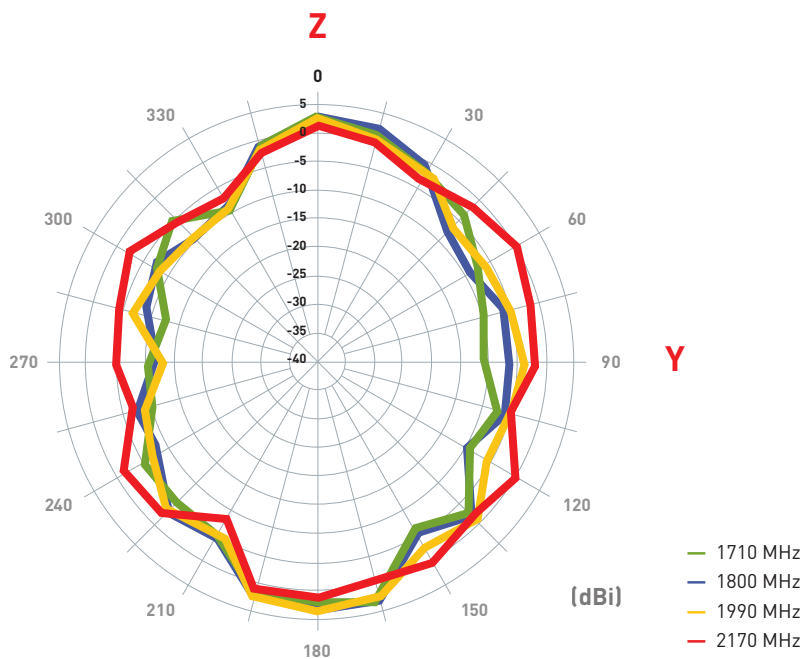

### 4.6.1 Antenna bent 90 with 90mmx150mm ground plane

#### XY Plane

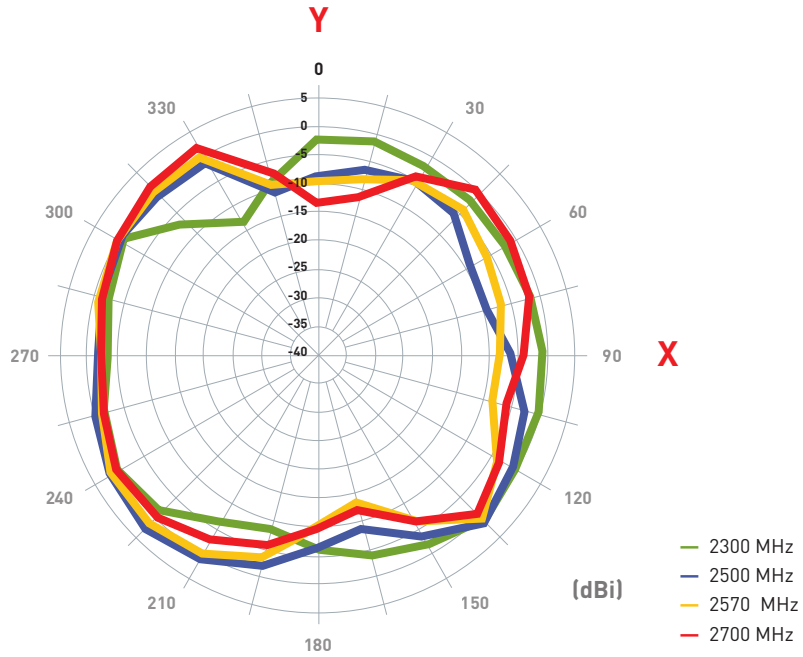

#### XZ Plane

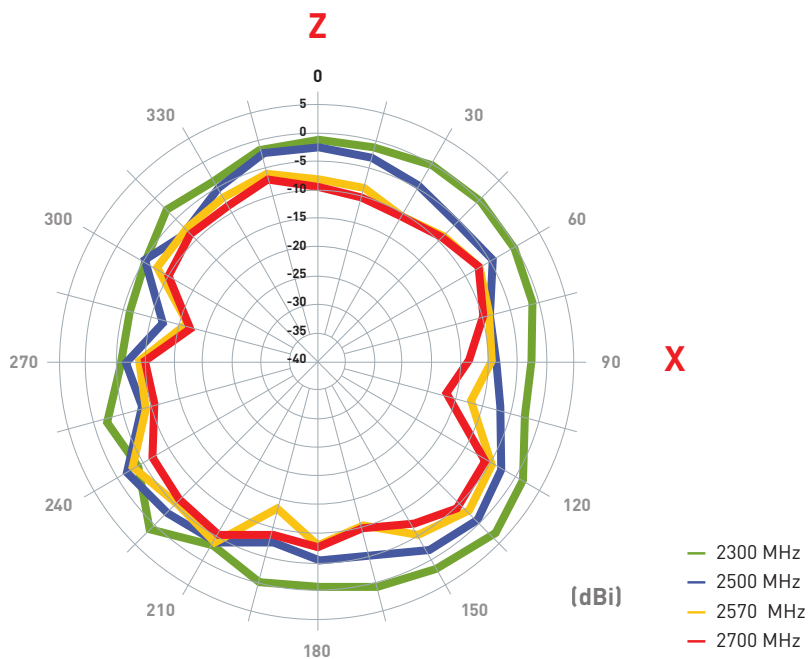

### 4.6.1 Antenna bent 90 with 90mmx150mm ground plane

#### YZ Plane

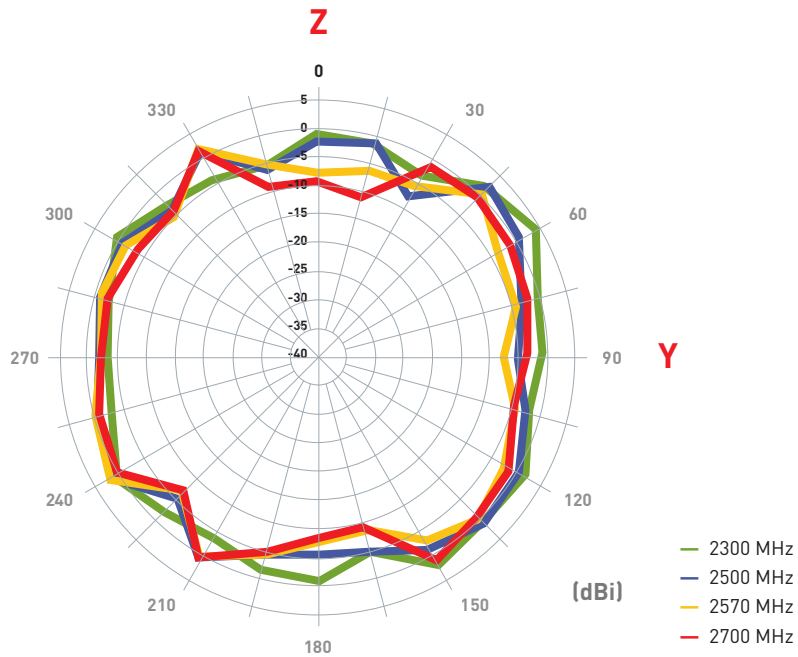

#### XY Plane

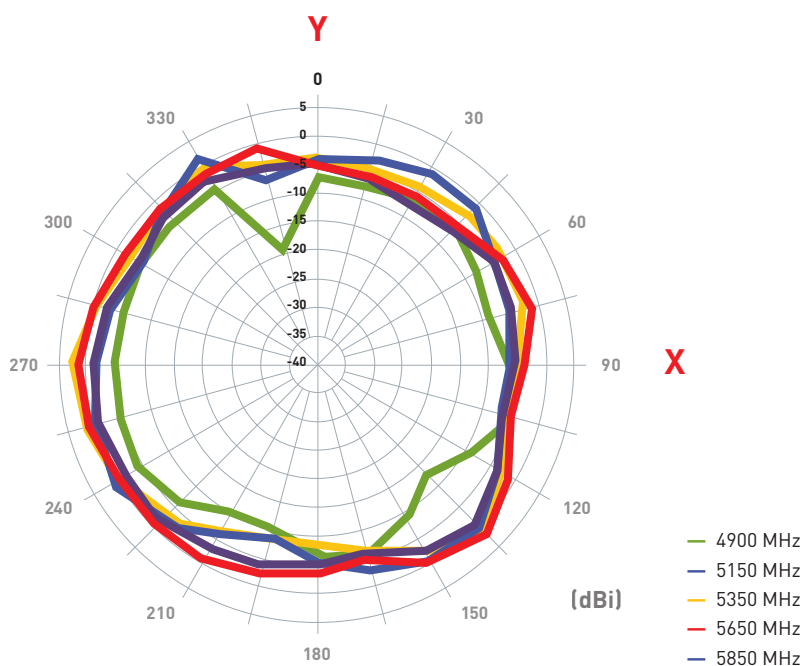

### 4.6.1 Antenna bent 90 with 90mmx150mm ground plane

#### XZ Plane

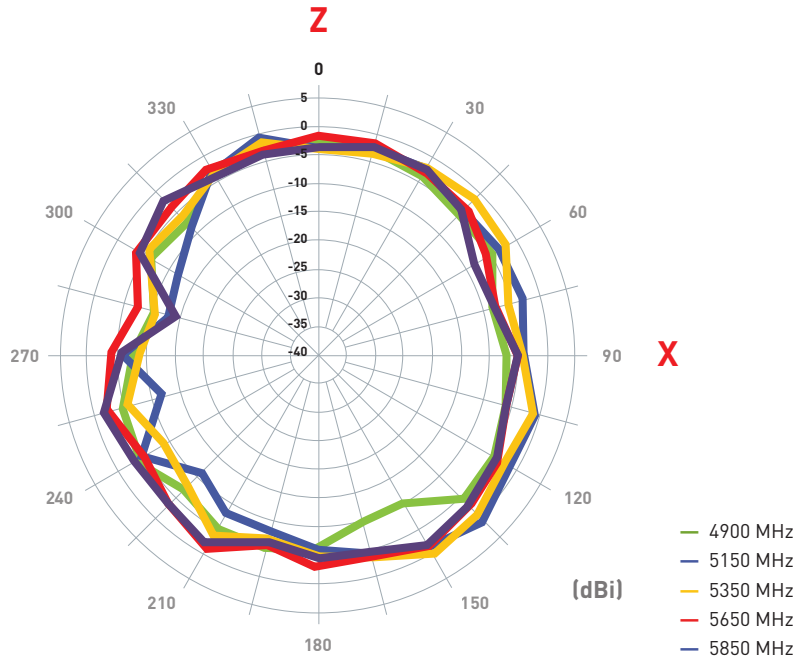

#### YZ Plane

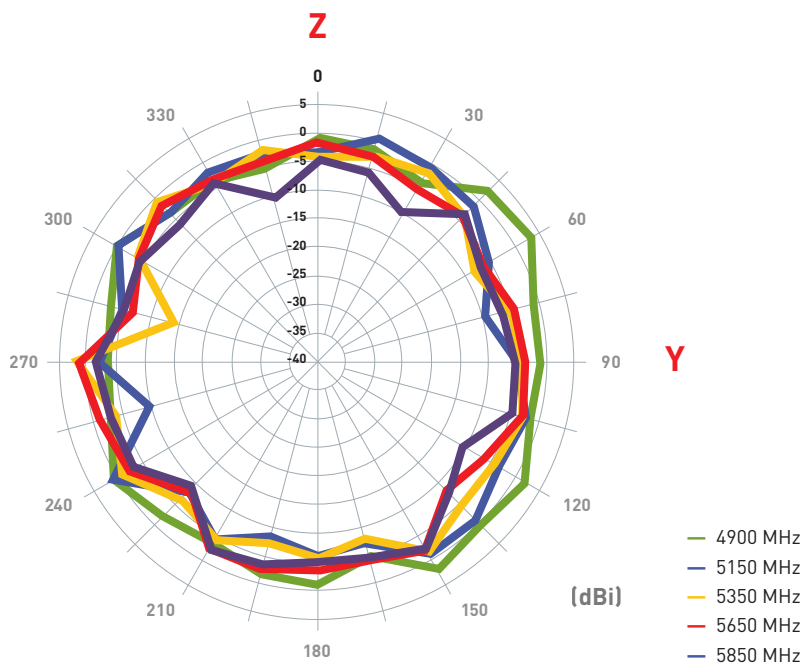

#### 4.7 Antenna setup - Antenna bent 90 with 90mmx150mm ground plane

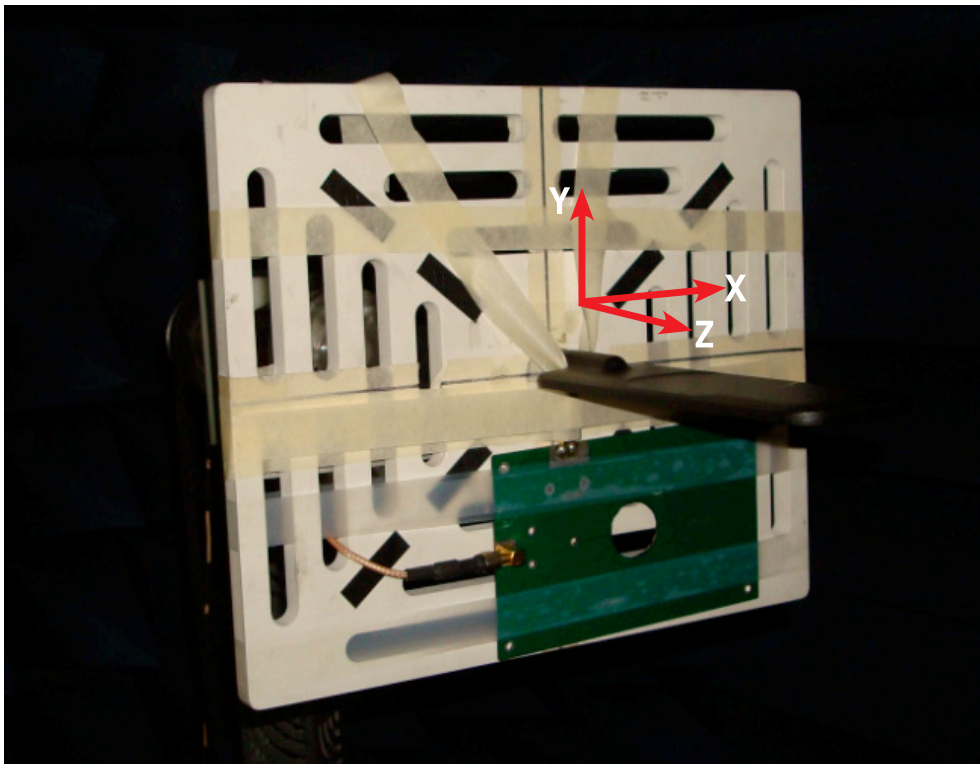



## 4.8 Antenna radiation patterns

### 4.8.1 Antenna bent 90 with 90mmx150mm ground plane

#### XY Plane

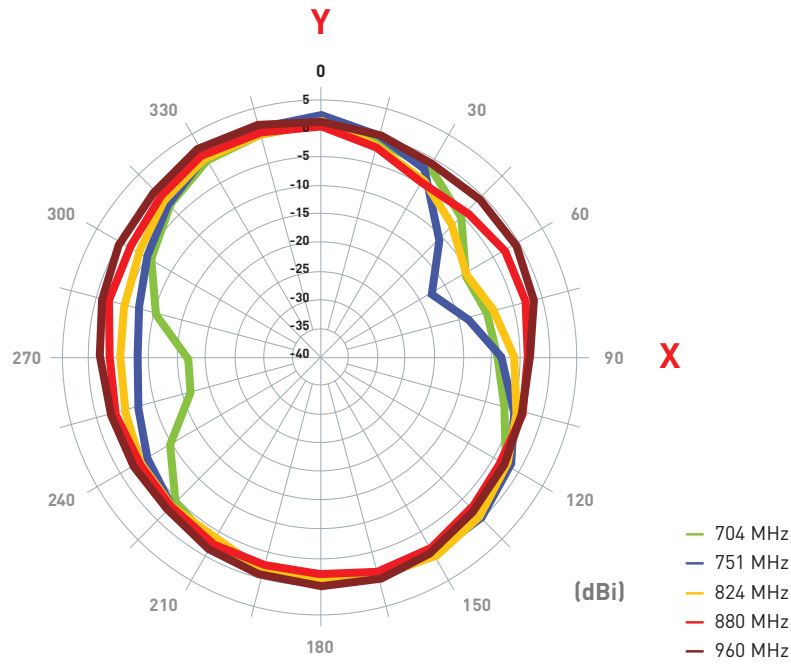

#### XZ Plane

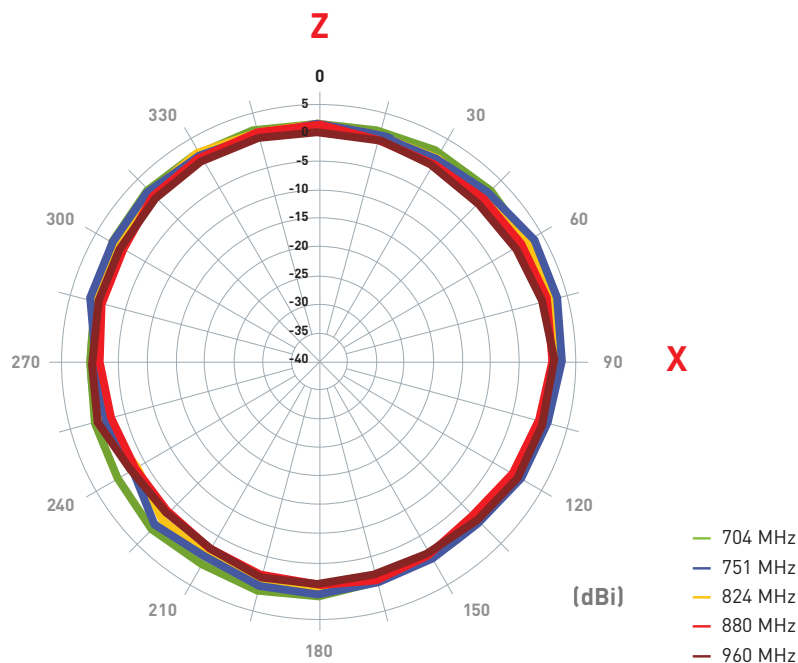

### 4.8.1 Antenna bent 90 with 90mmx150mm ground plane

#### YZ Plane

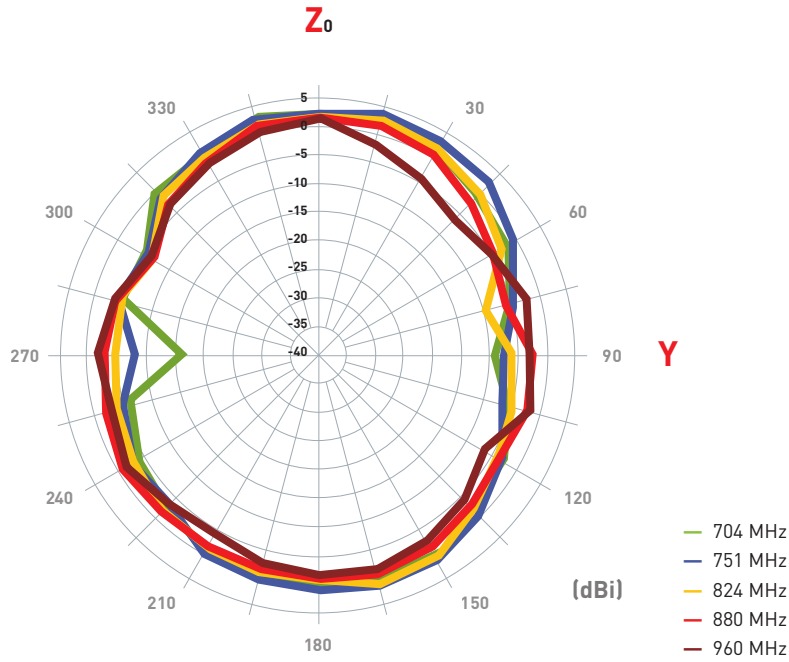

#### XY Plane

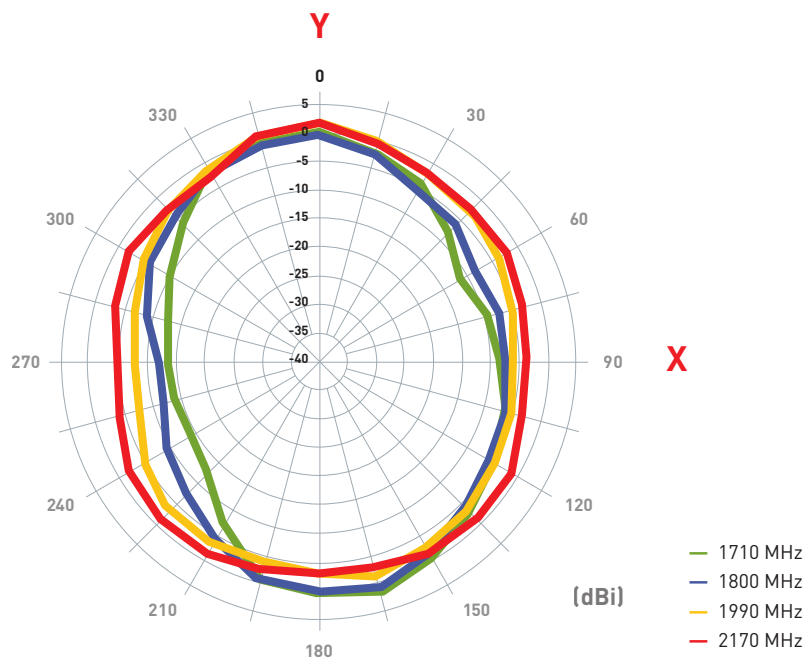

### 4.8.1 Antenna bent 90 with 90mmx150mm ground plane

#### XZ Plane

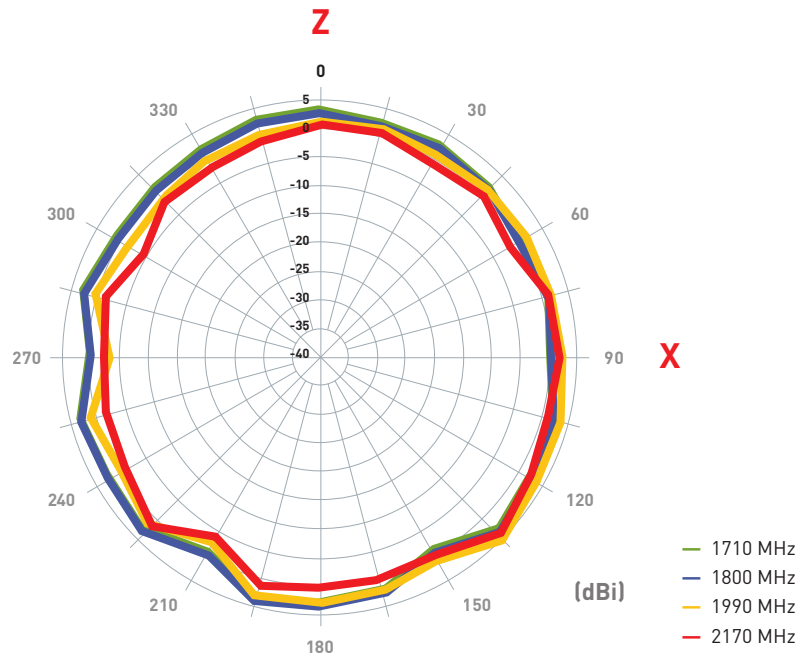

#### YZ Plane

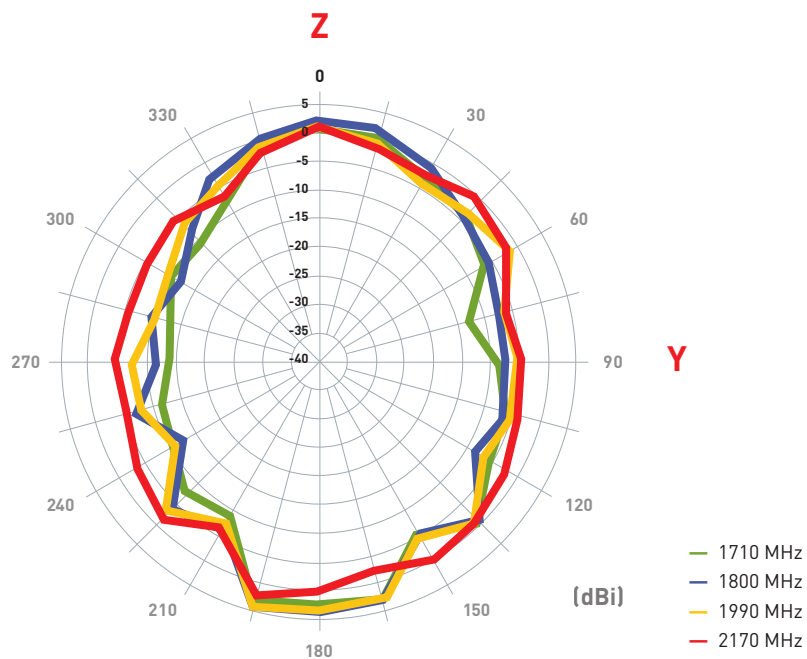

### 4.8.1 Antenna bent 90 with 90mmx150mm ground plane

#### XY Plane

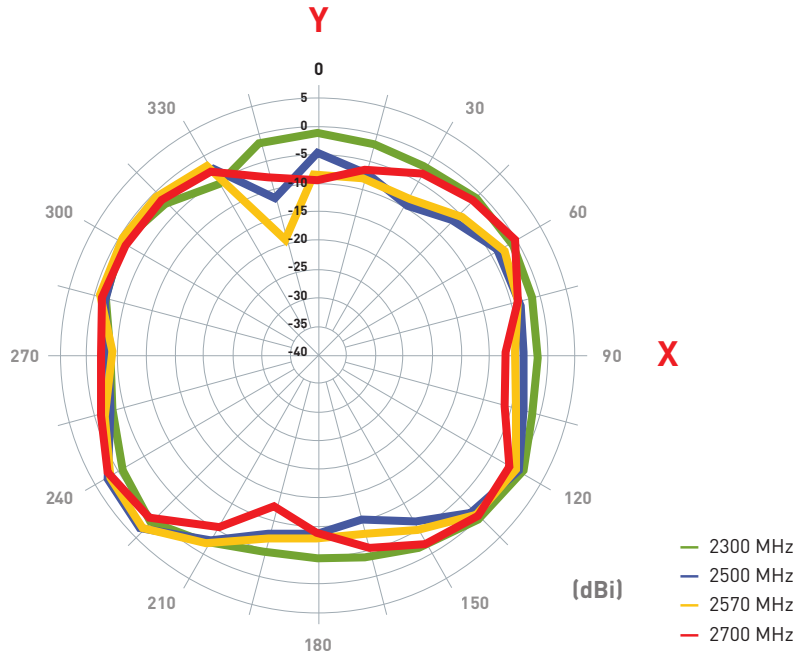

#### XZ Plane

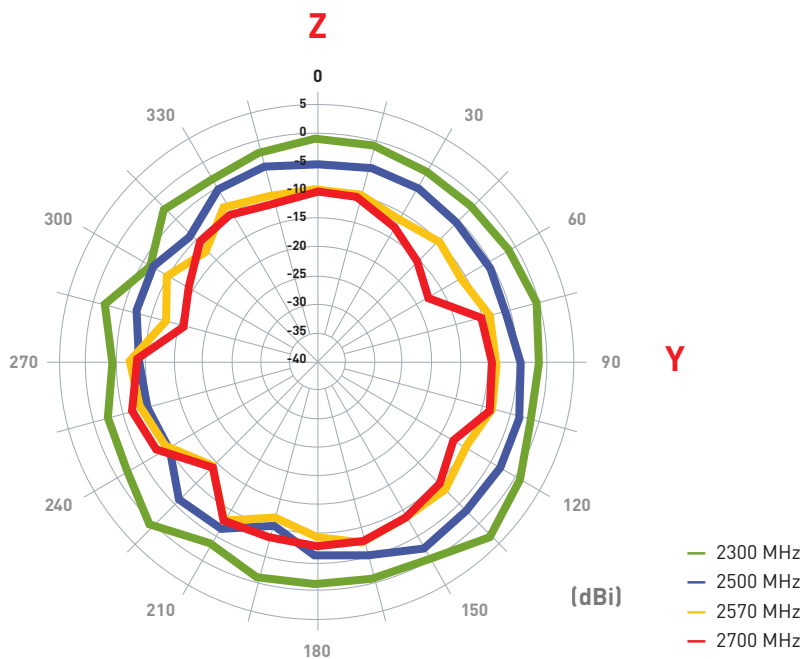

### 4.8.1 Antenna bent 90 with 90mmx150mm ground plane

#### YZ Plane

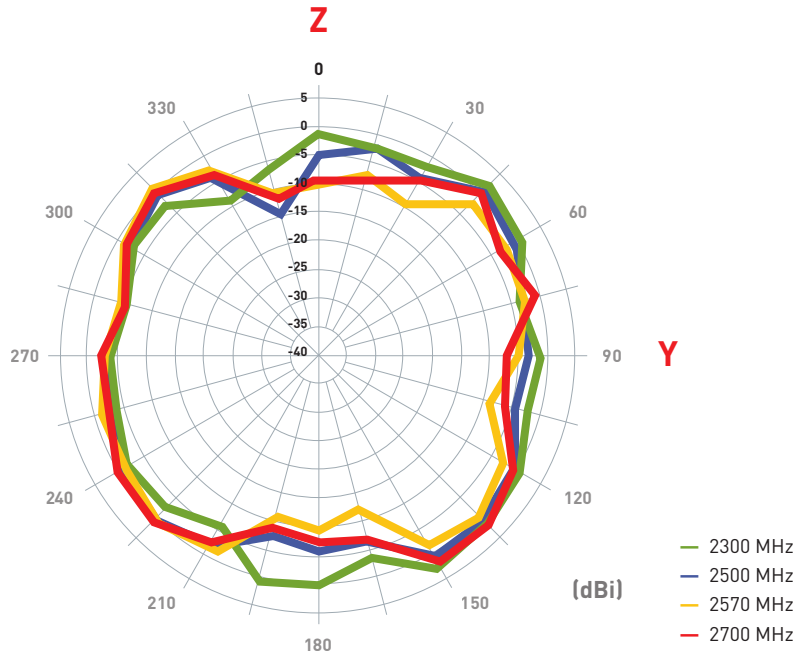

#### XY Plane

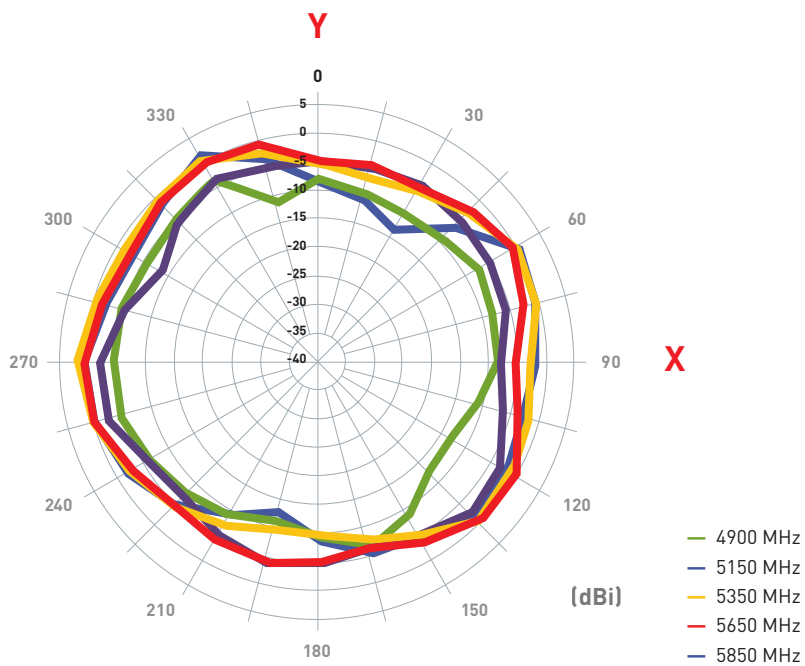

### 4.8.1 Antenna bent 90 with 90mmx150mm ground plane

#### XZ Plane

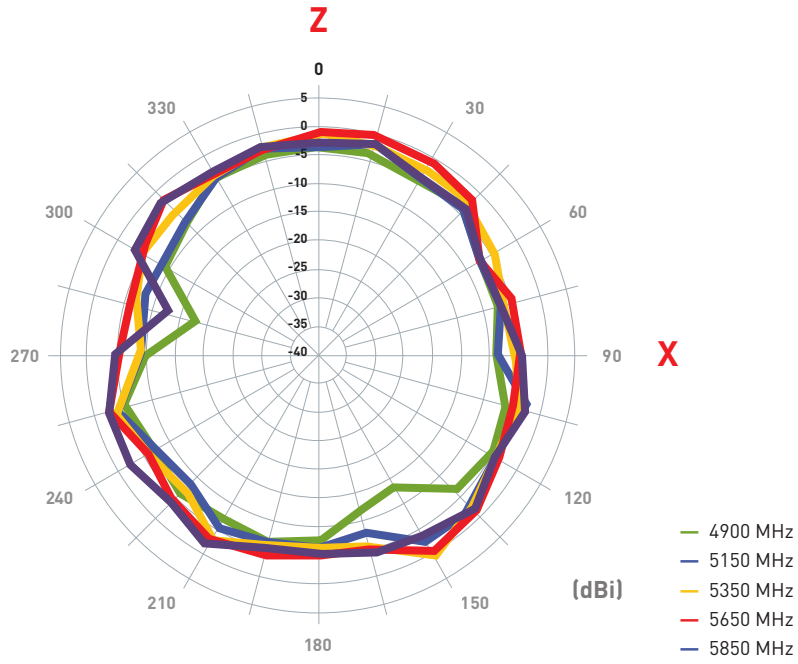

#### YZ Plane

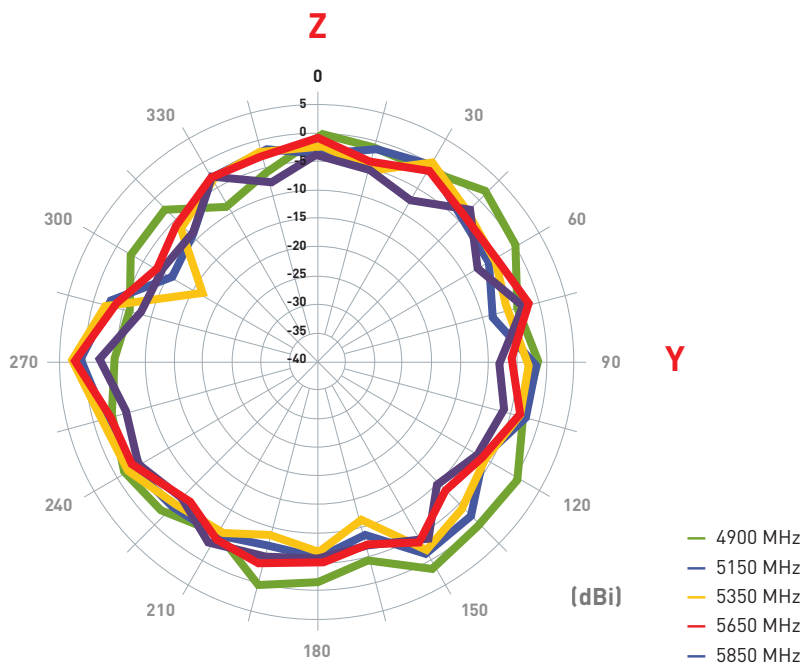

#### 4.9 Antenna setup - Antenna straight with 30x30cm ground plane center

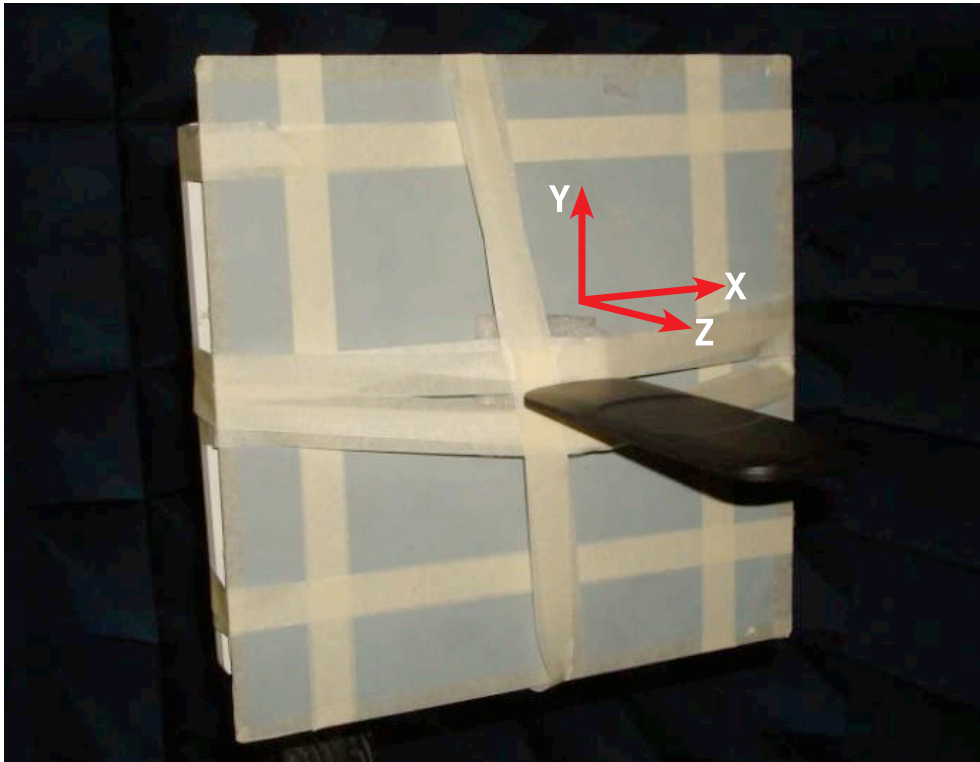

## 4.10 Antenna radiation patterns

### 4.10.1 Antenna straight with 30x30cm ground plane center

#### XY Plane

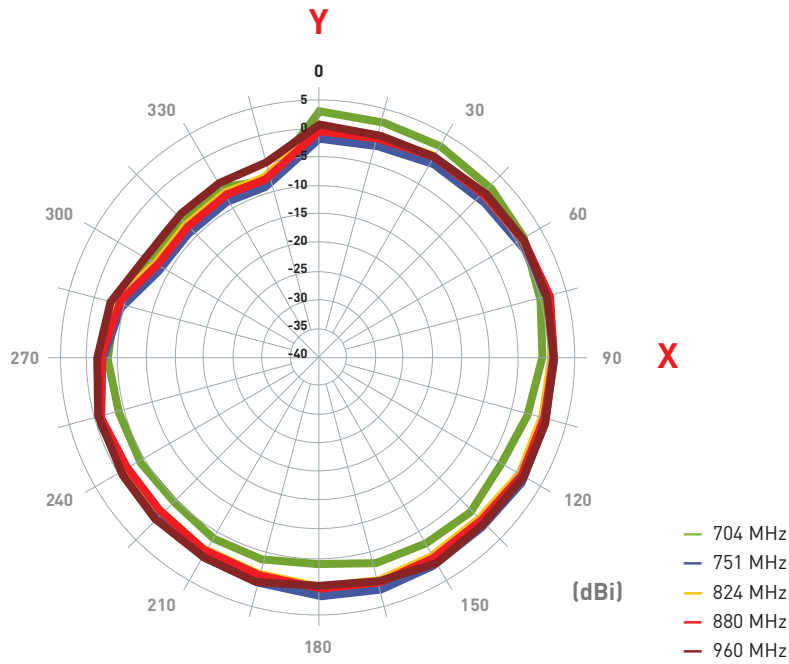

#### XZ Plane

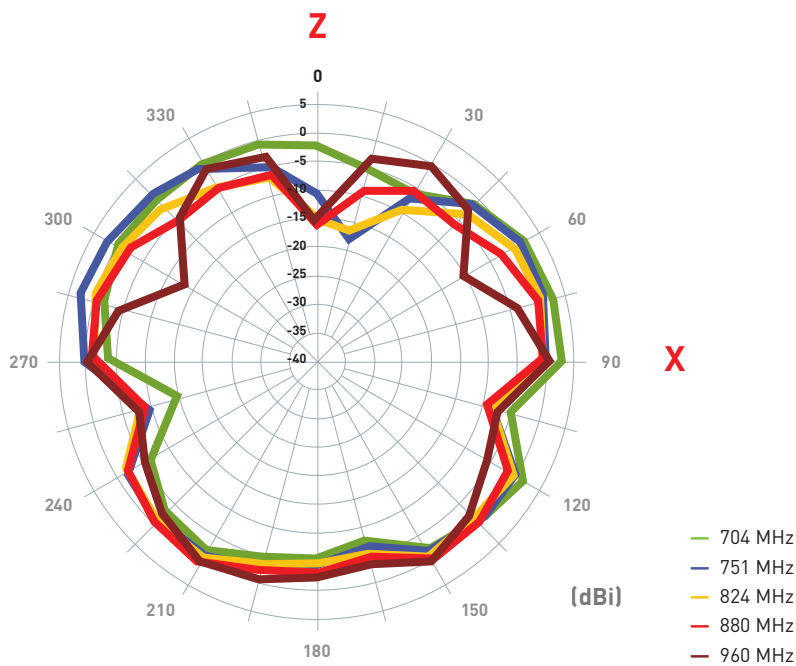



### 4.10.1 Antenna straight with 30x30cm ground plane center

#### YZ Plane

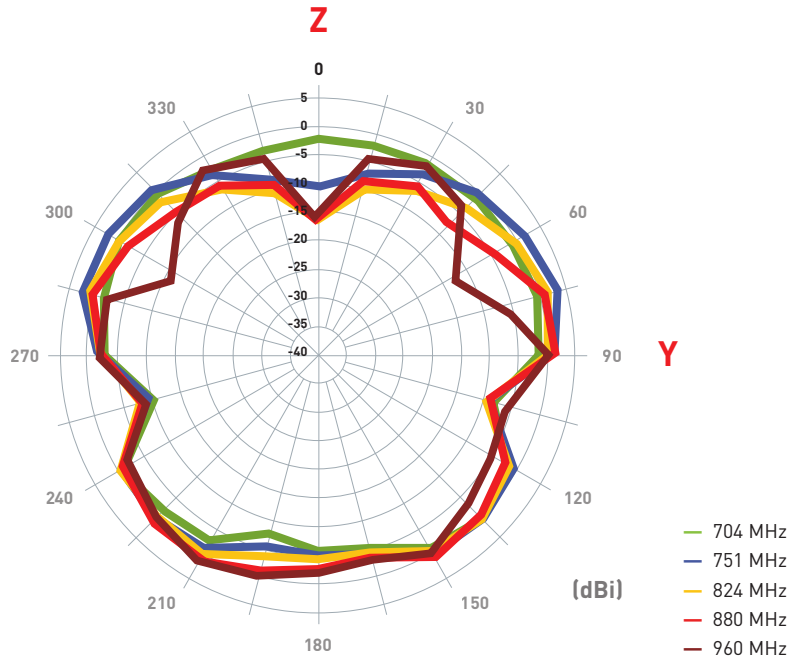

#### XY Plane

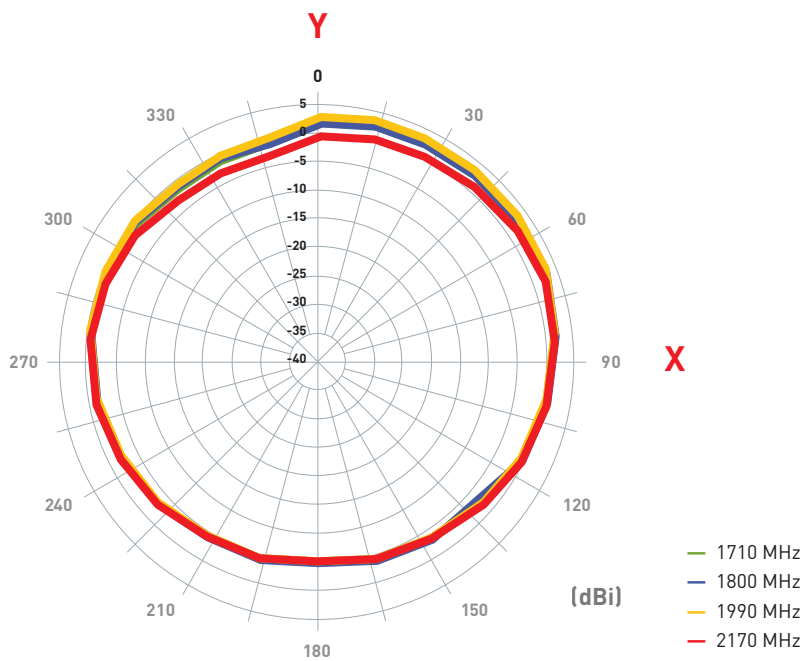

### 4.10.1 Antenna straight with 30x30cm ground plane center

#### XZ Plane

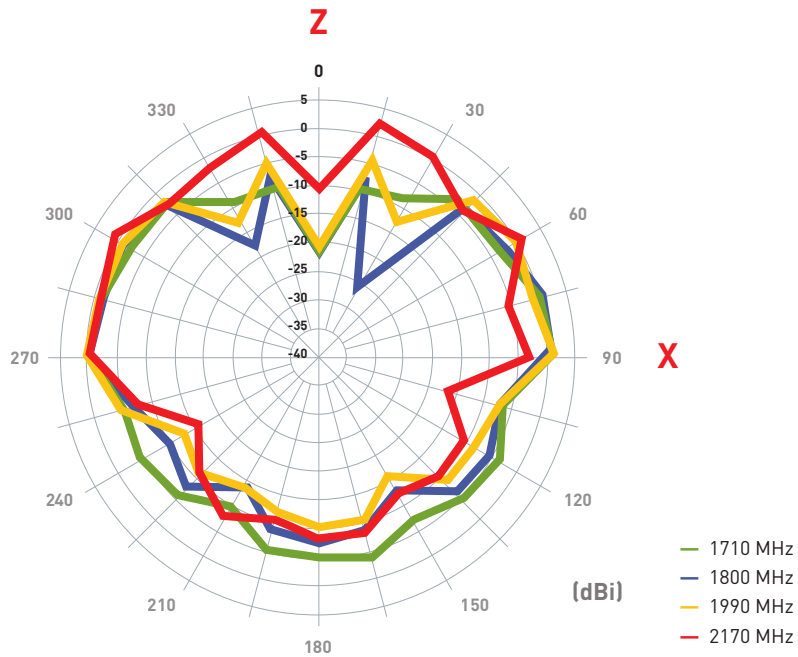

#### YZ Plane

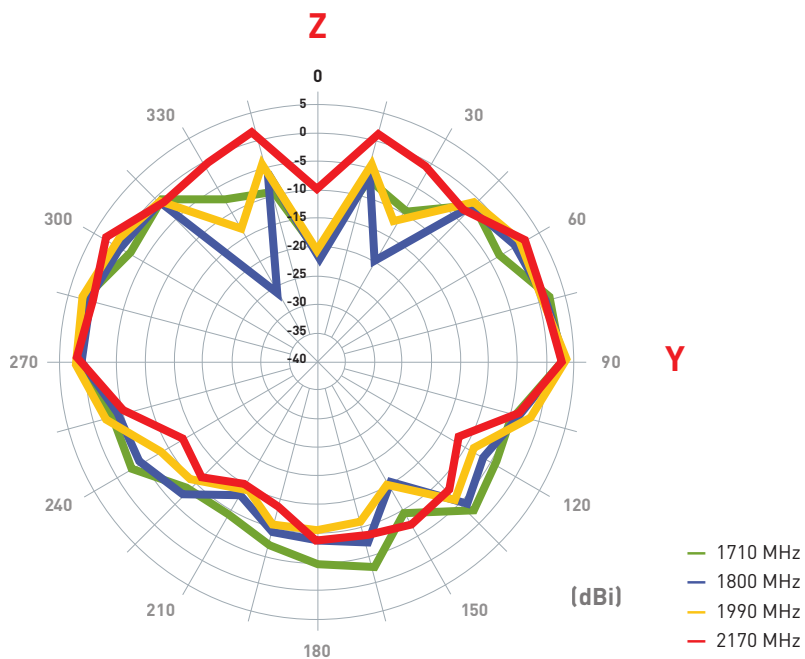

### 4.10.1 Antenna straight with 30x30cm ground plane center

#### XY Plane

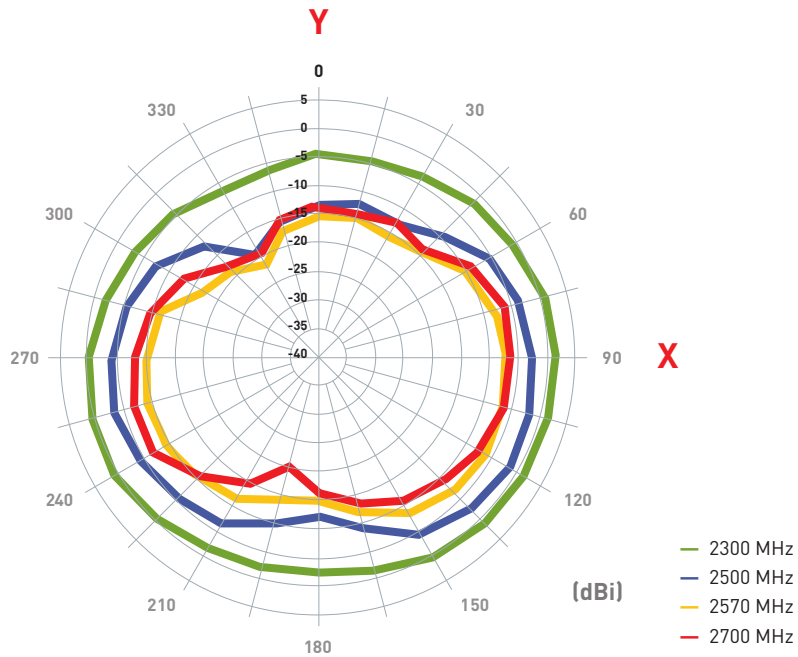

#### XZ Plane

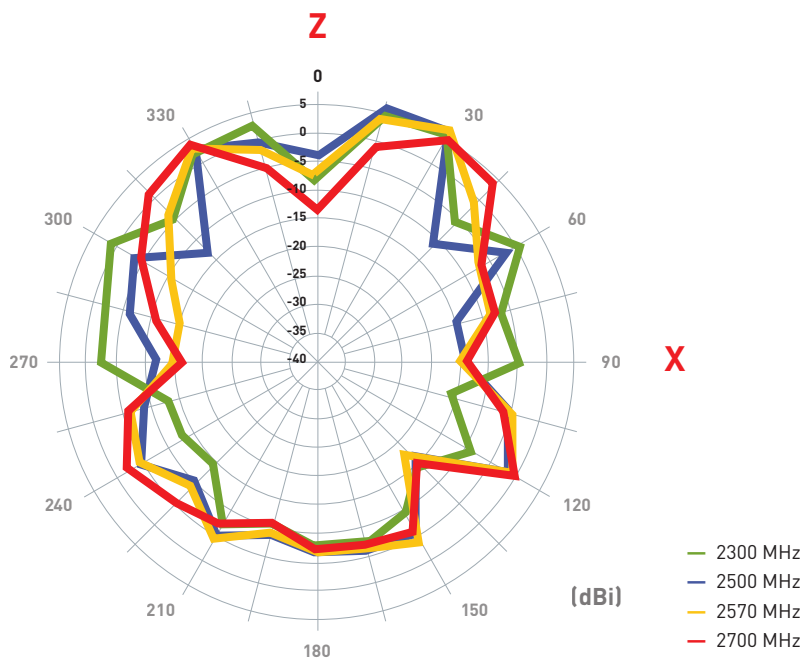

### 4.10.1 Antenna straight with 30x30cm ground plane center

#### YZ Plane

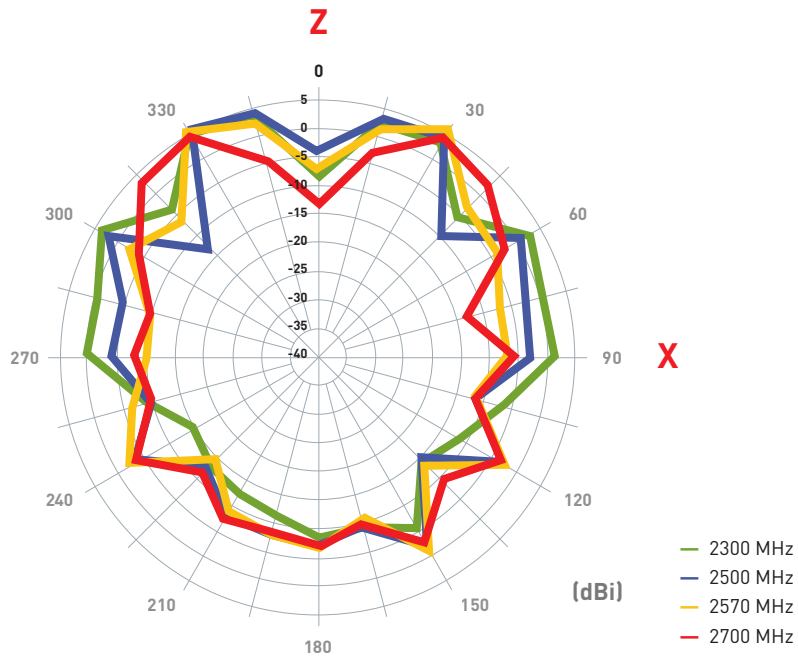

#### XY Plane

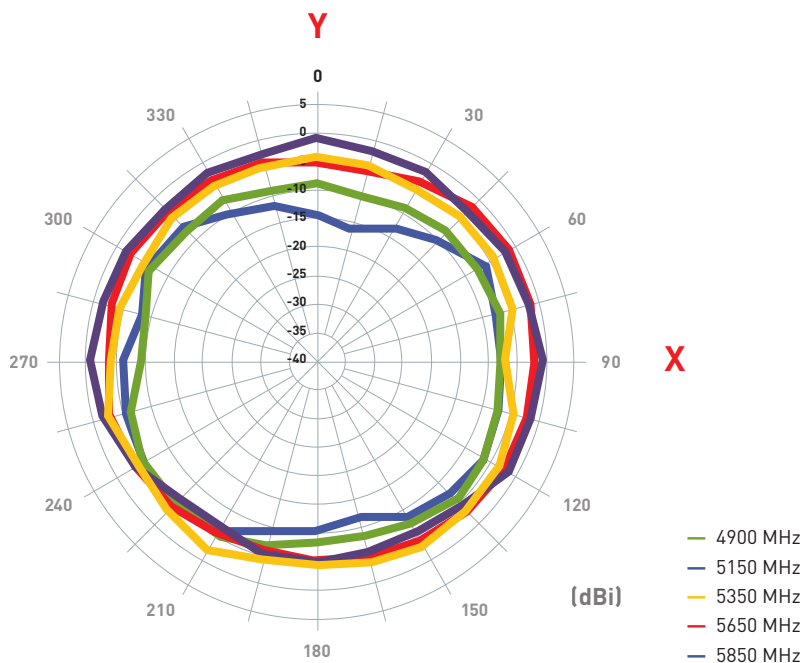

### 4.10.1 Antenna straight with 30x30cm ground plane center

#### XZ Plane

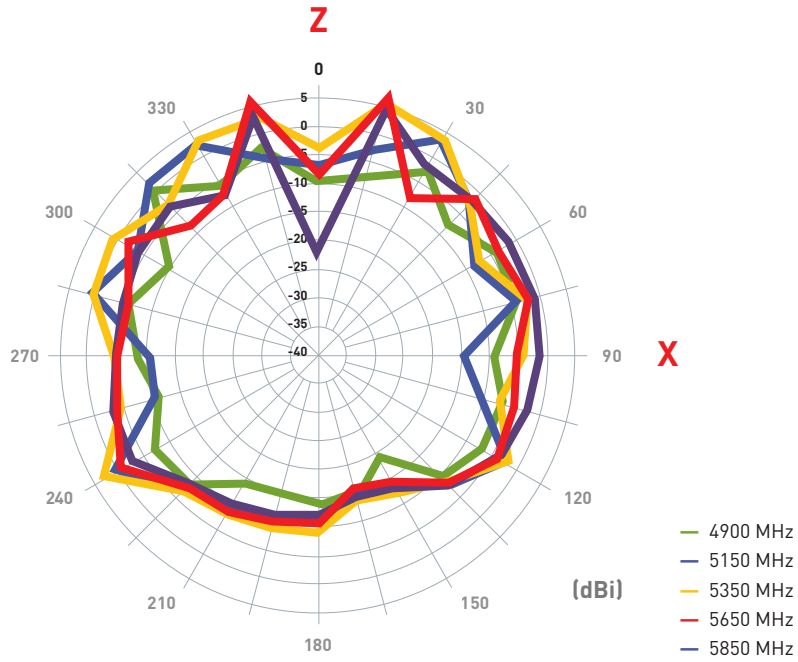

#### YZ Plane

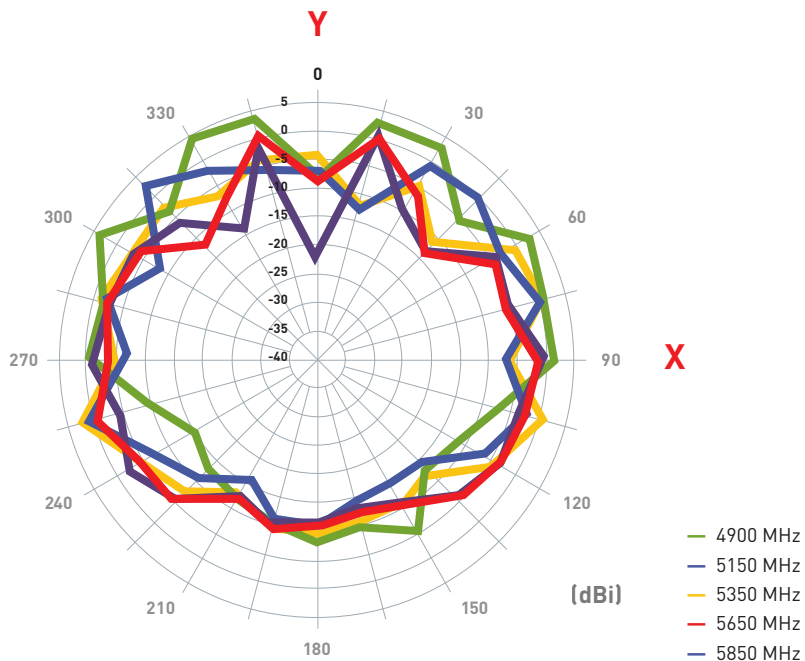

#### 4.11 Antenna setup - Antenna bent 90 with 30x30cm ground plane center

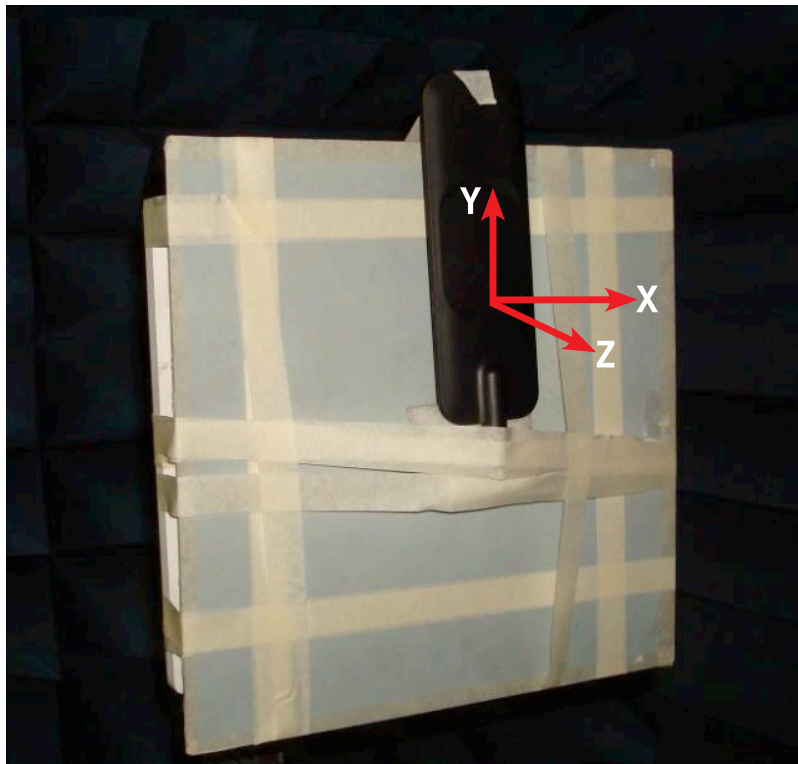

## 4.12 Antenna radiation patterns

### 4.12.1 Antenna bent 90 with 30x30cm ground plane center

#### XY Plane

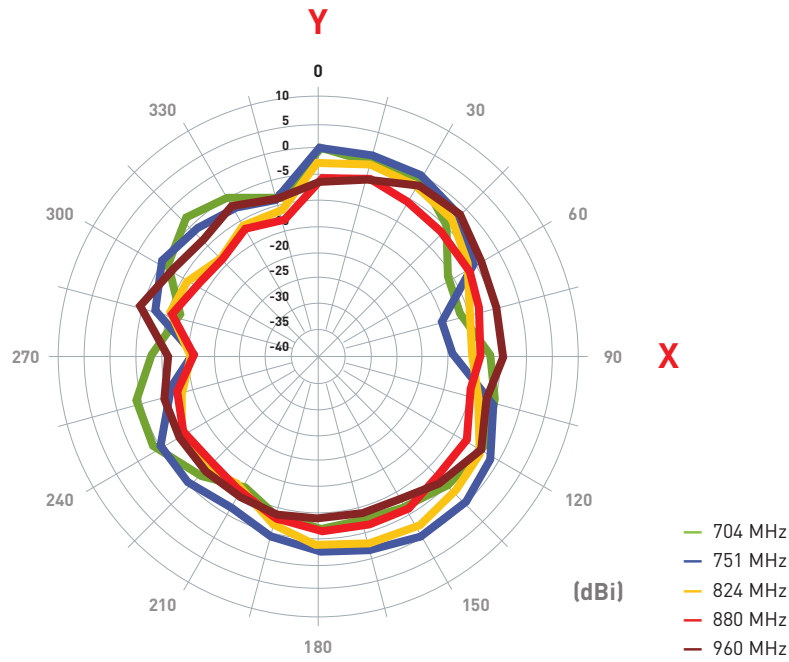

#### XZ Plane

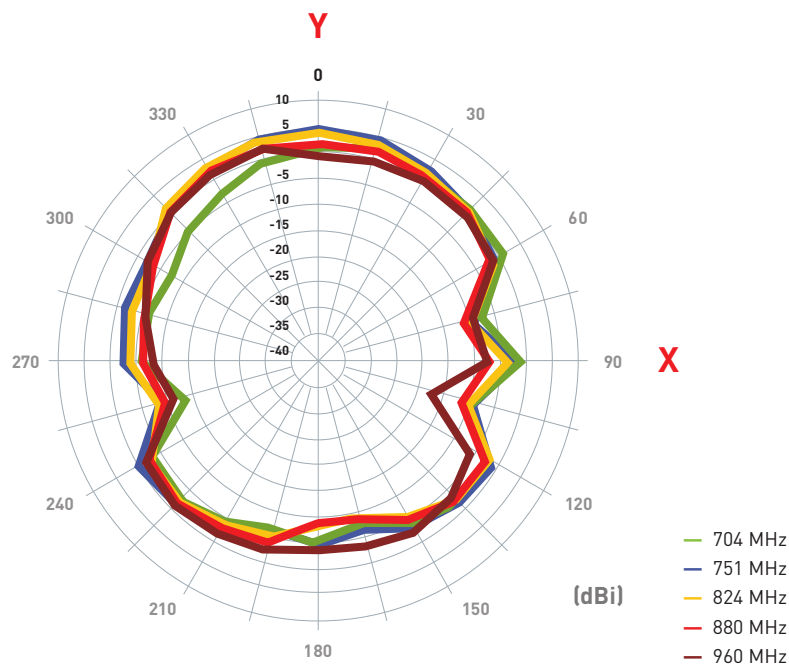

### 4.12.1 Antenna bent 90 with 30x30cm ground plane center

#### YZ Plane

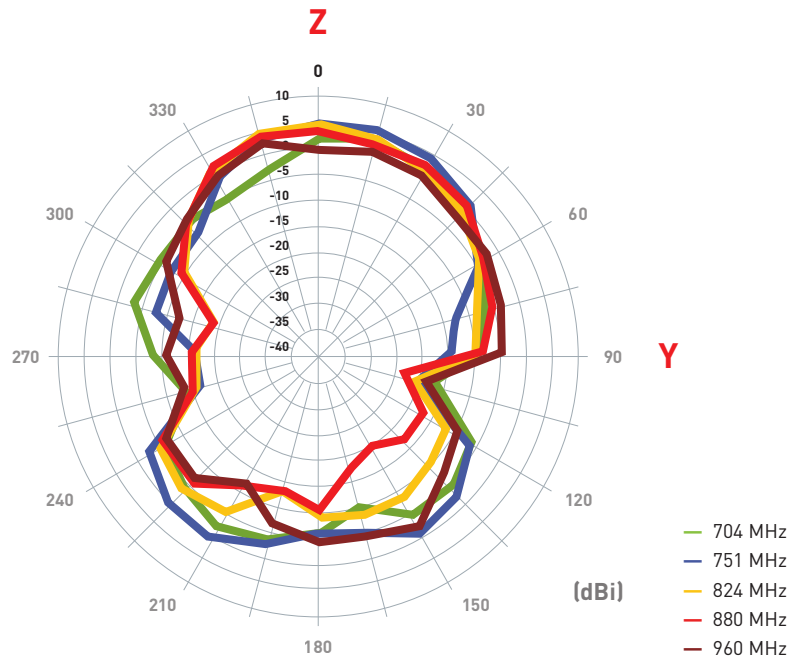

#### XY Plane

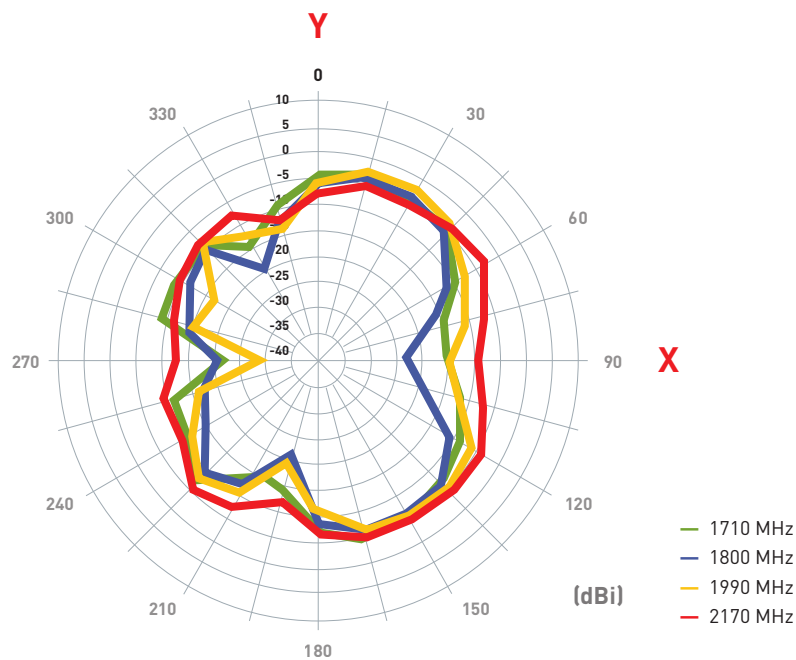



### 4.12.1 Antenna bent 90 with 30x30cm ground plane center

#### XZ Plane

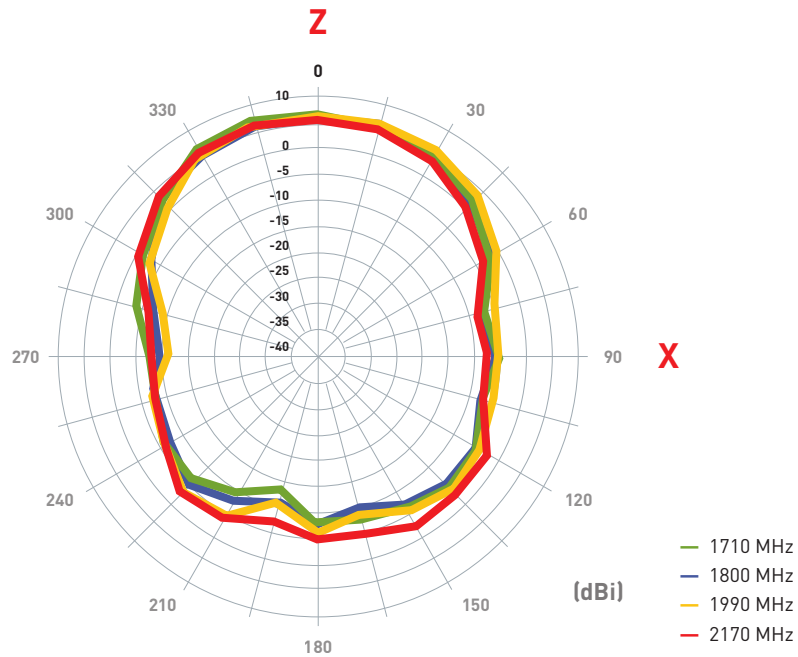

#### ZY Plane

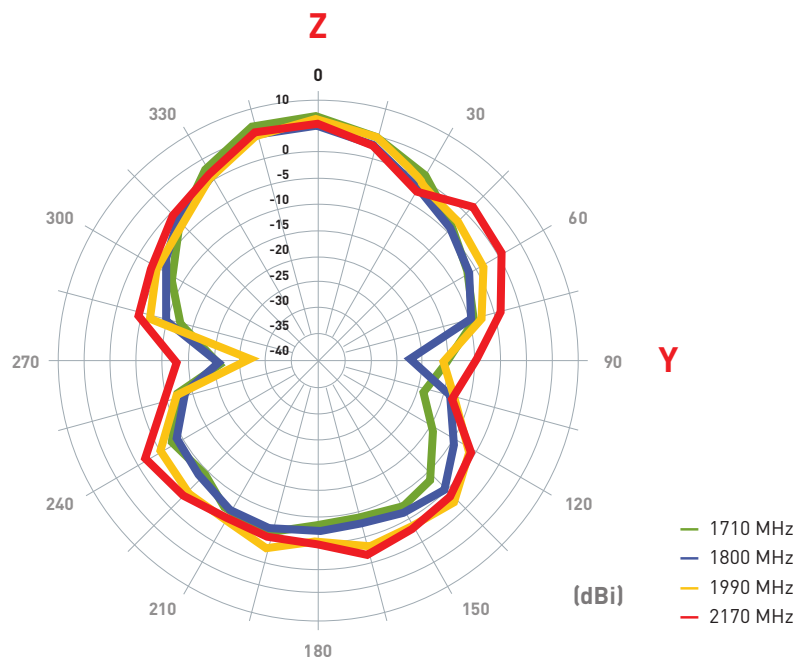

### 4.12.1 Antenna bent 90 with 30x30cm ground plane center

#### XY Plane

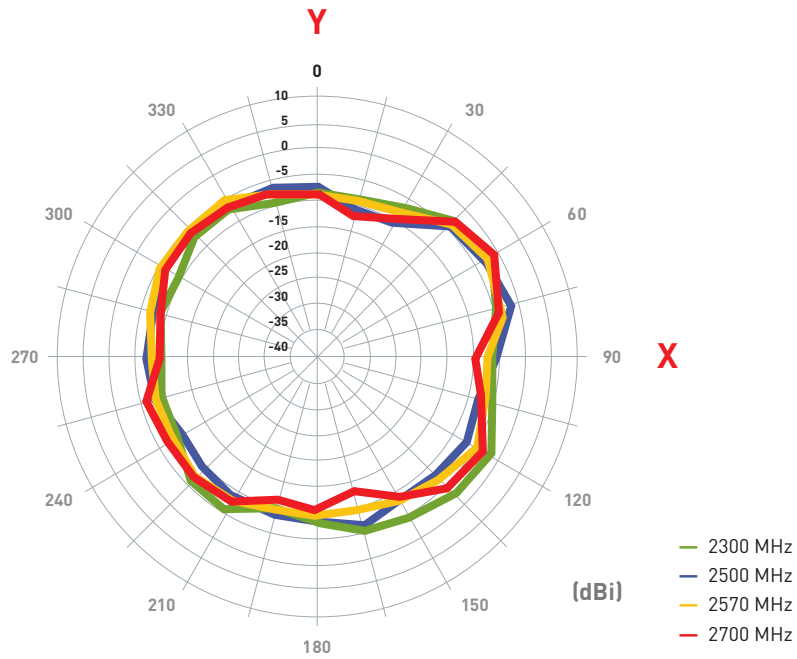

#### XZ Plane

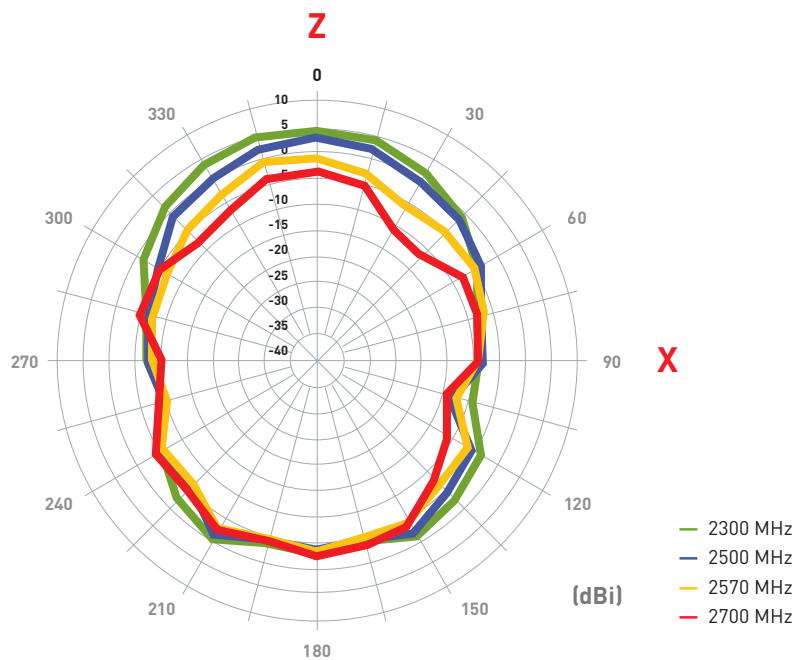

### 4.12.1 Antenna bent 90 with 30x30cm ground plane center

#### YZ Plane

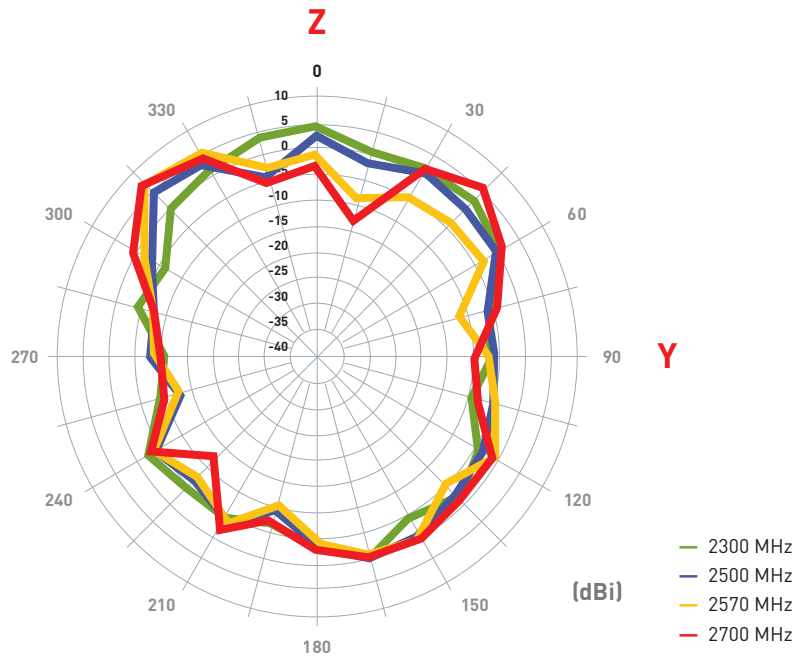

#### XY Plane

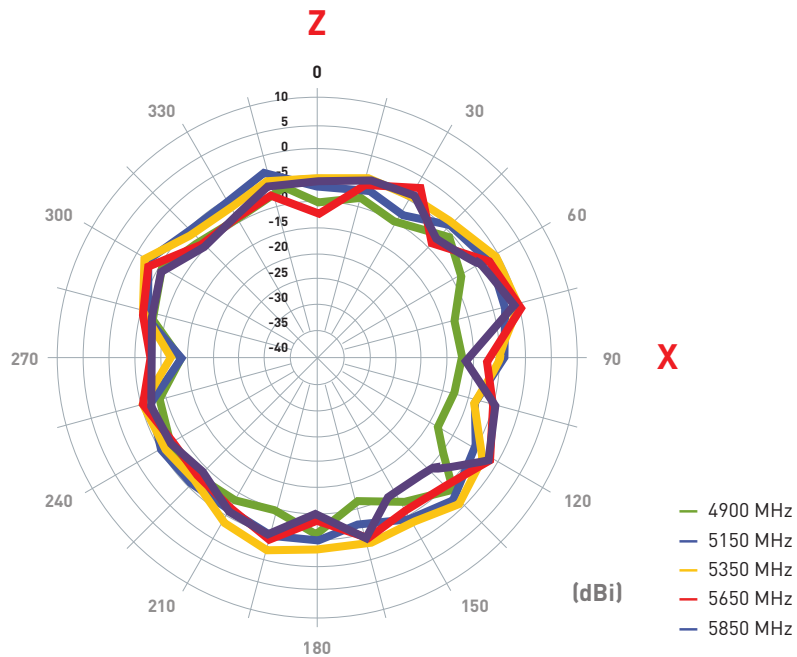

### 4.12.1 Antenna bent 90 with 30x30cm ground plane center

#### XZ Plane

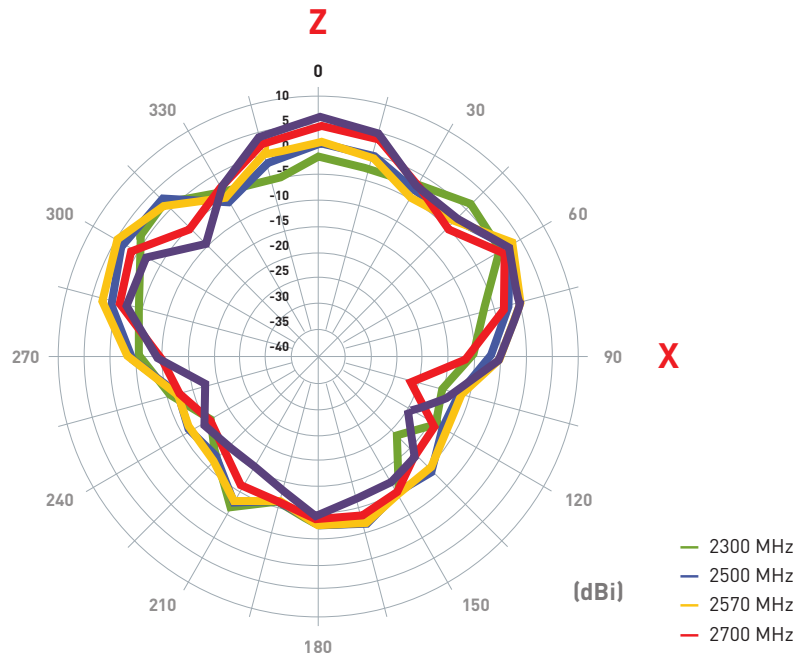

#### YZ Plane

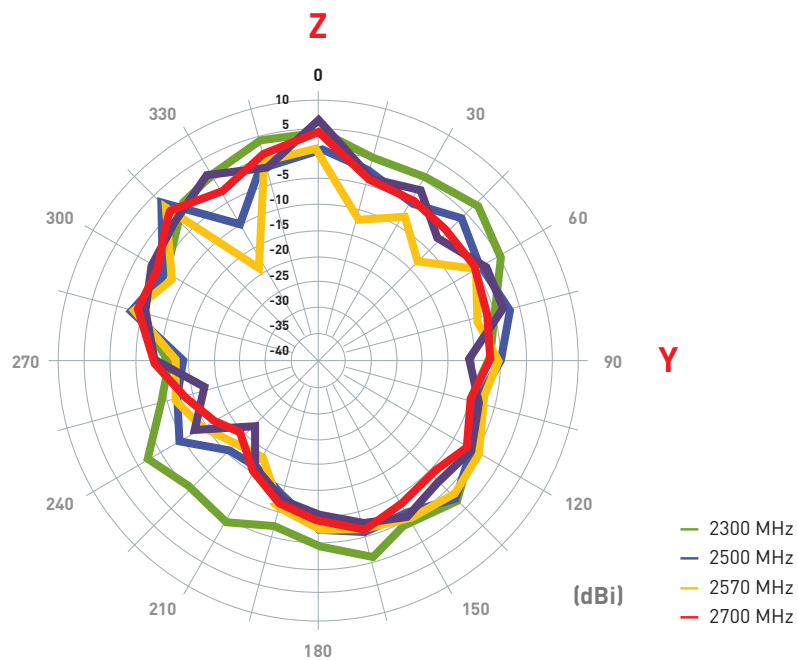

#### 4.13 Antenna setup - Antenna straight with 30x30cm ground plane edge

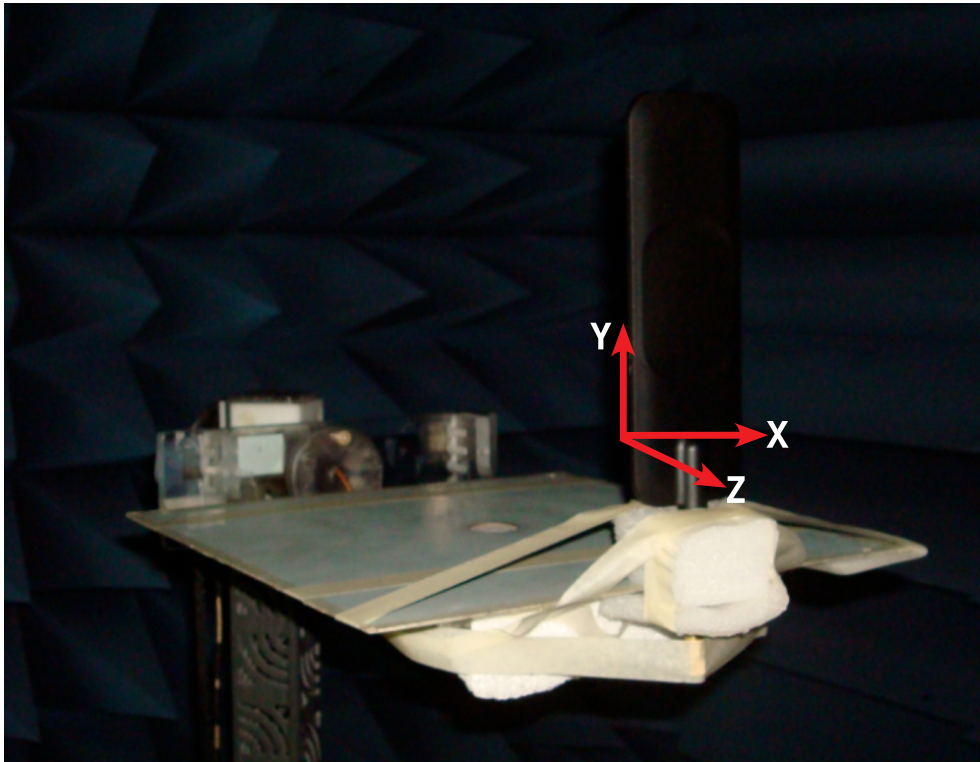

## 4.14 Antenna radiation patterns

### 4.14.1 Antenna straight with 30x30cm ground plane edge

#### XY Plane

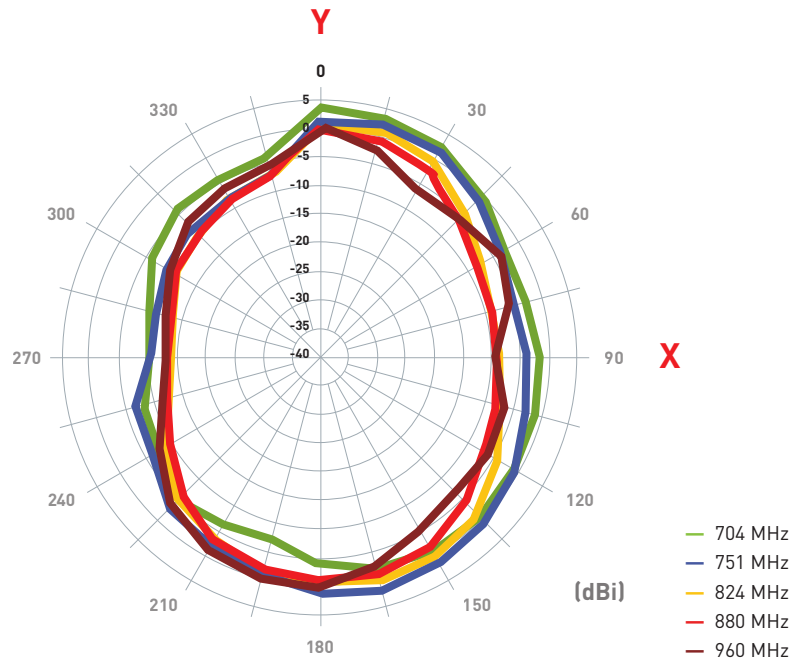

#### XZ Plane

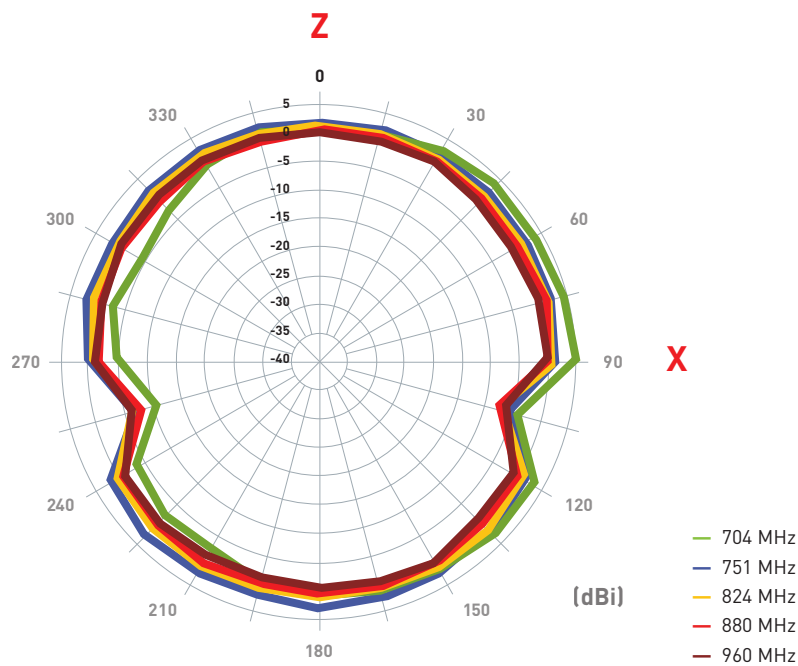

### 4.14.1 Antenna straight with 30x30cm ground plane edge

#### YZ Plane

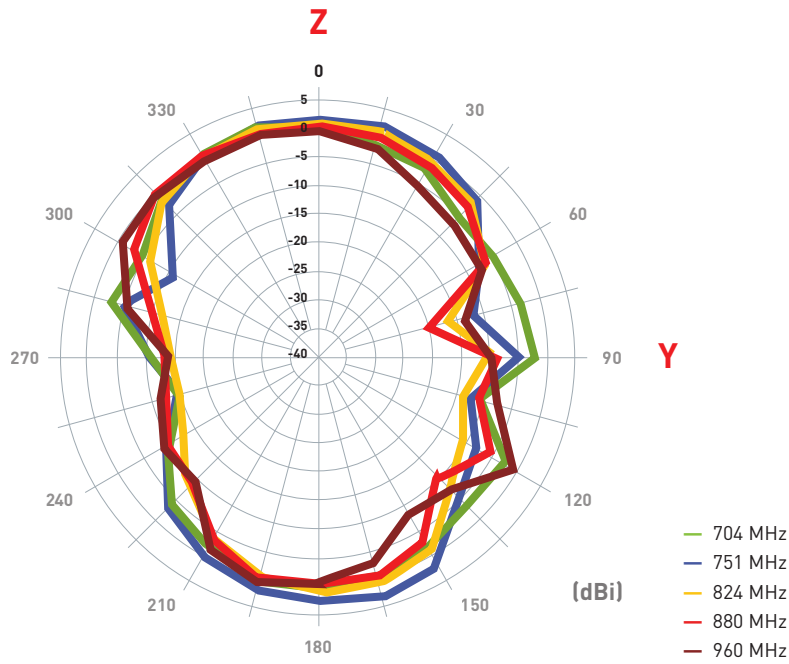

#### XY Plane

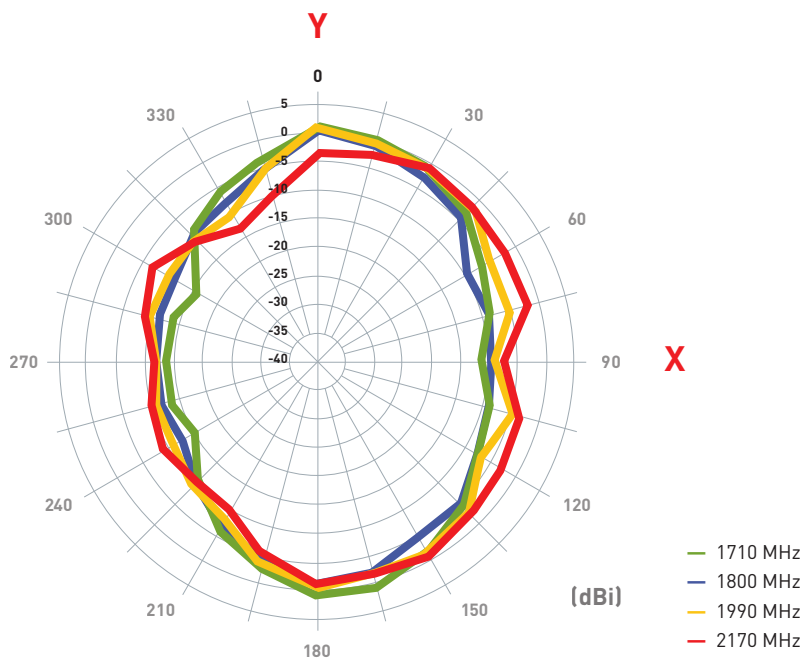

### 4.14.1 Antenna straight with 30x30cm ground plane edge

#### XZ Plane

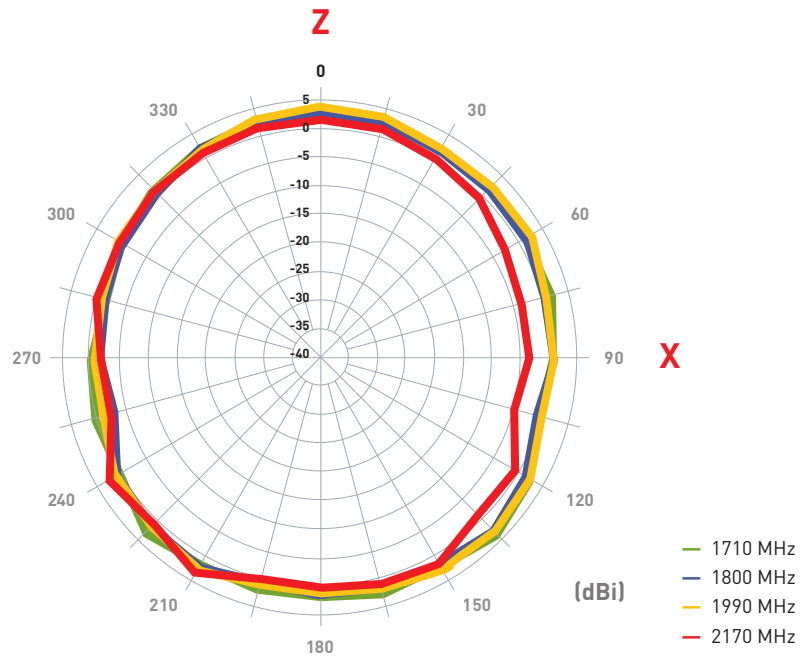

#### YZ Plane

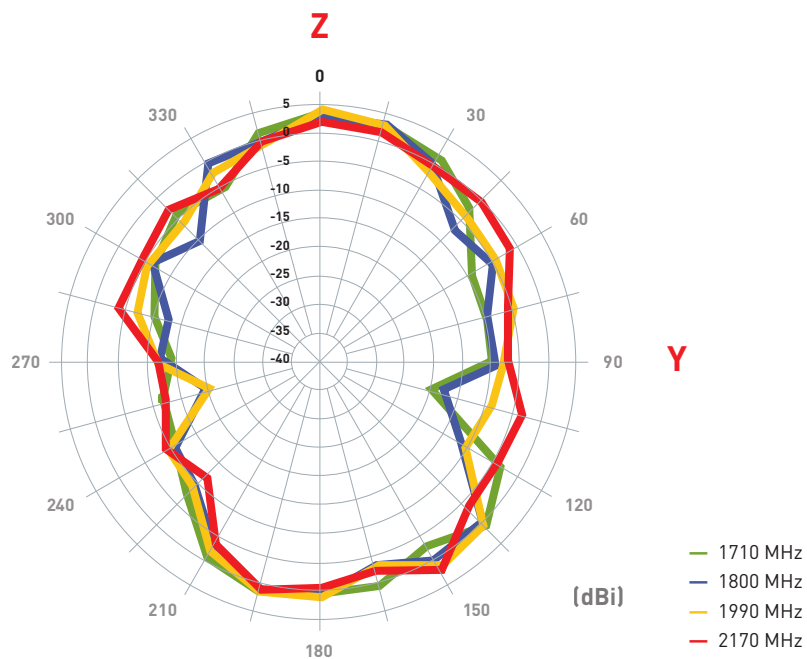



### 4.14.1 Antenna straight with 30x30cm ground plane edge

#### XY Plane

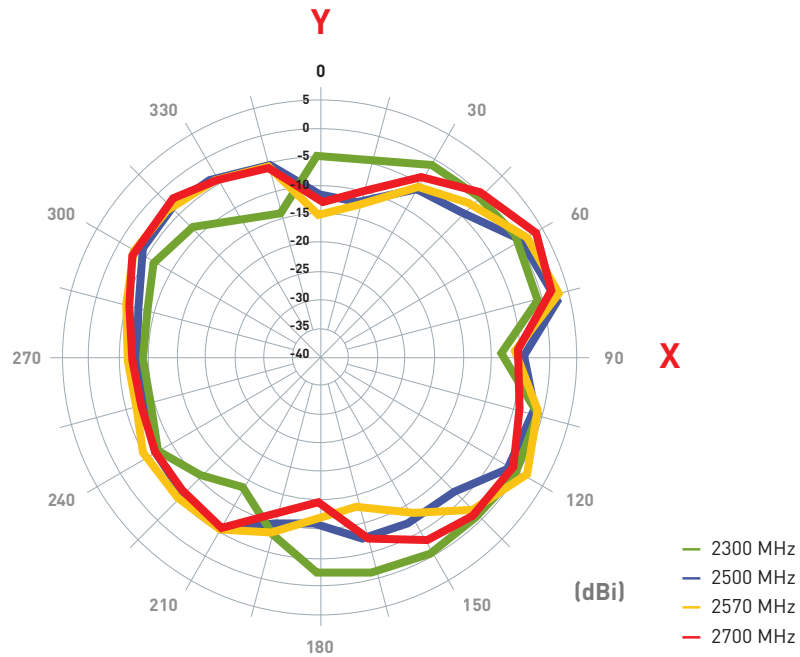

#### XZ Plane

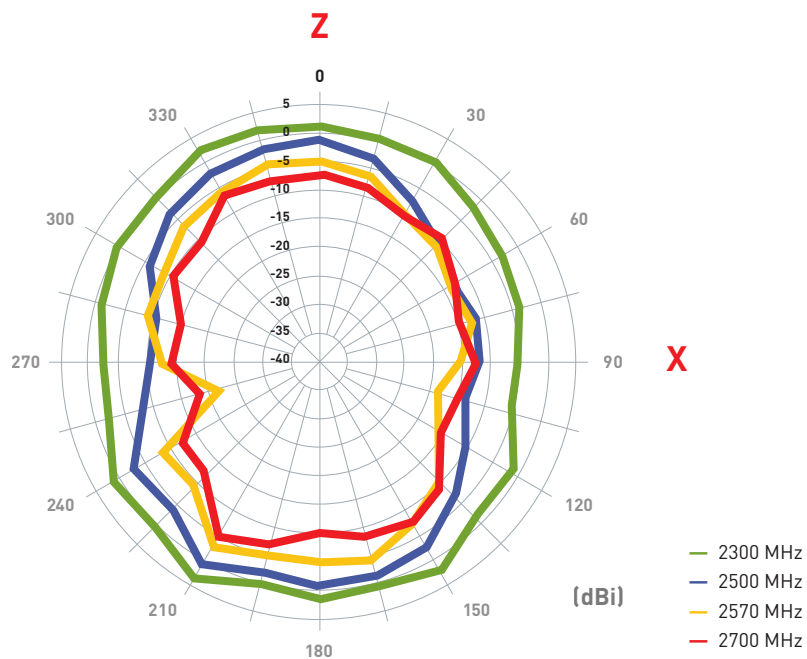

### 4.14.1 Antenna straight with 30x30cm ground plane edge

#### YZ Plane

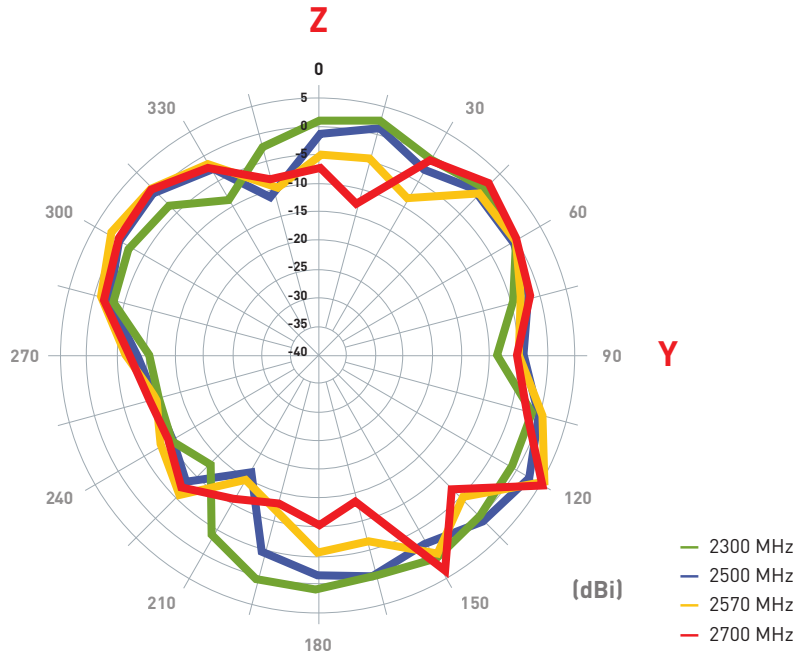

#### XY Plane

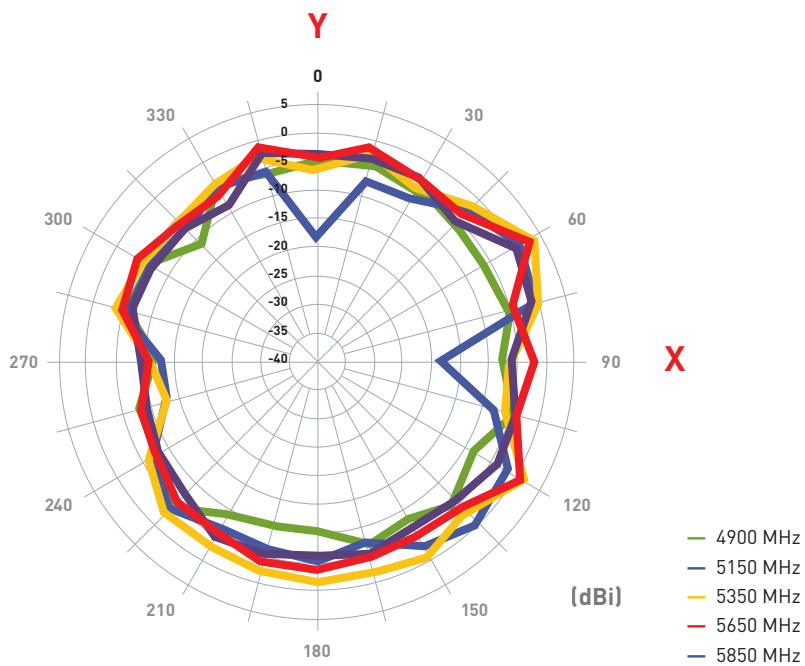

### 4.14.1 Antenna straight with 30x30cm ground plane edge

#### XZ Plane

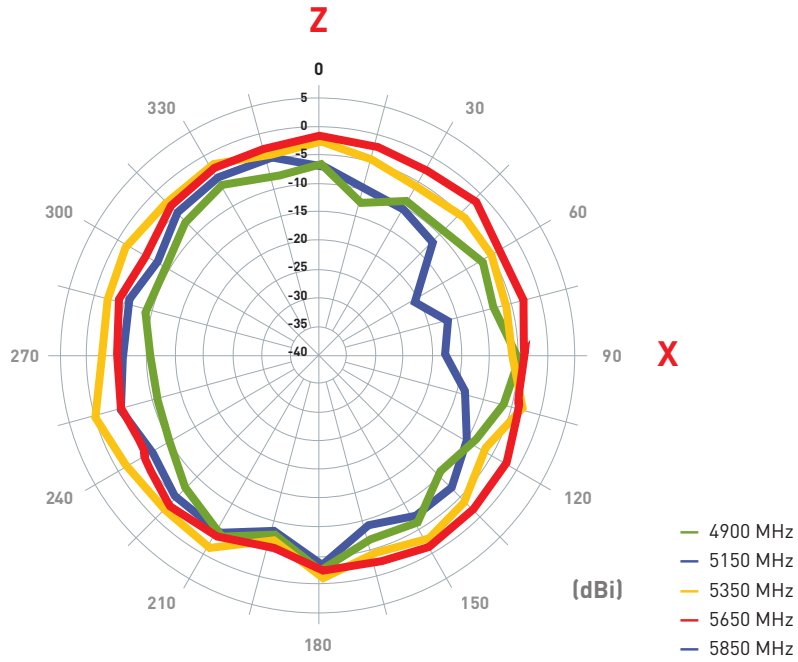

#### YZ Plane

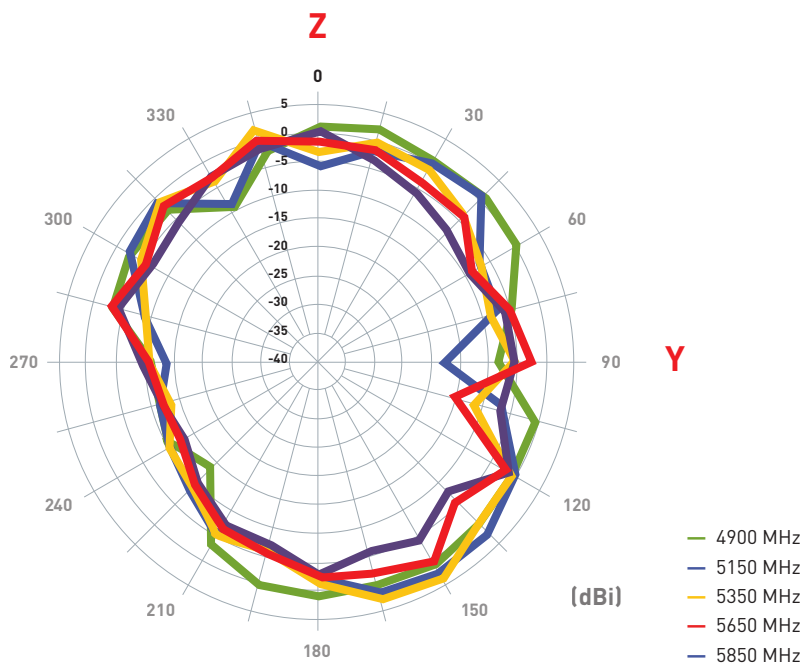

#### 4.15 Antenna setup - Antenna bent 90 with 30x30cm ground plane edge

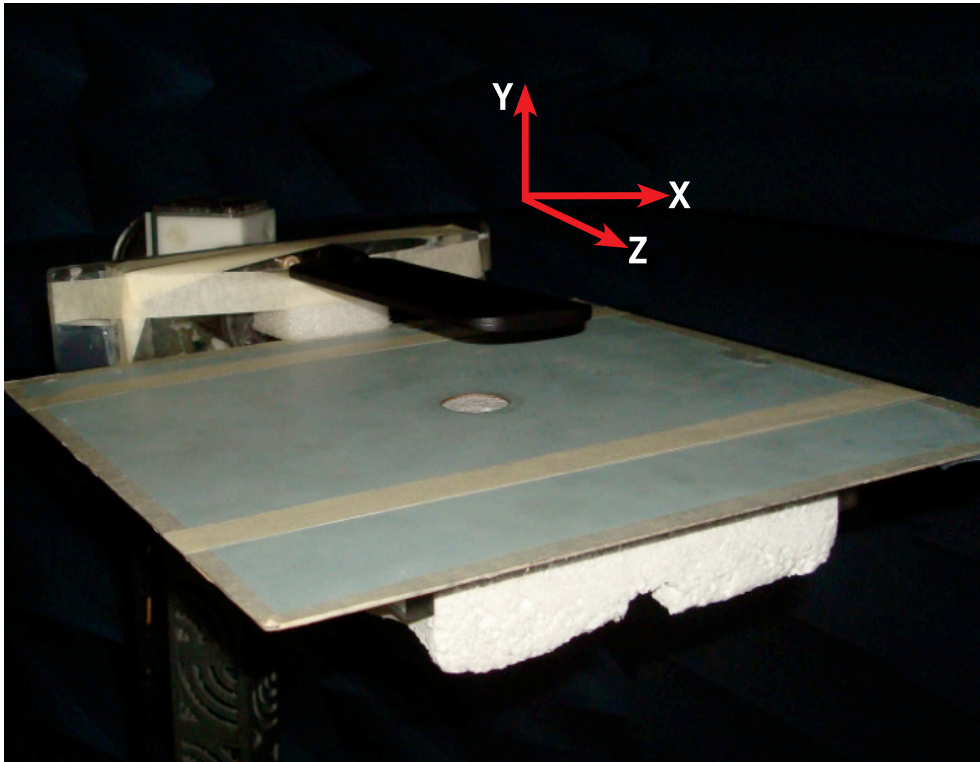

## 4.16 Antenna radiation patterns

### 4.16.1 Antenna bent 90 with 30x30cm ground plane edge

#### XY Plane

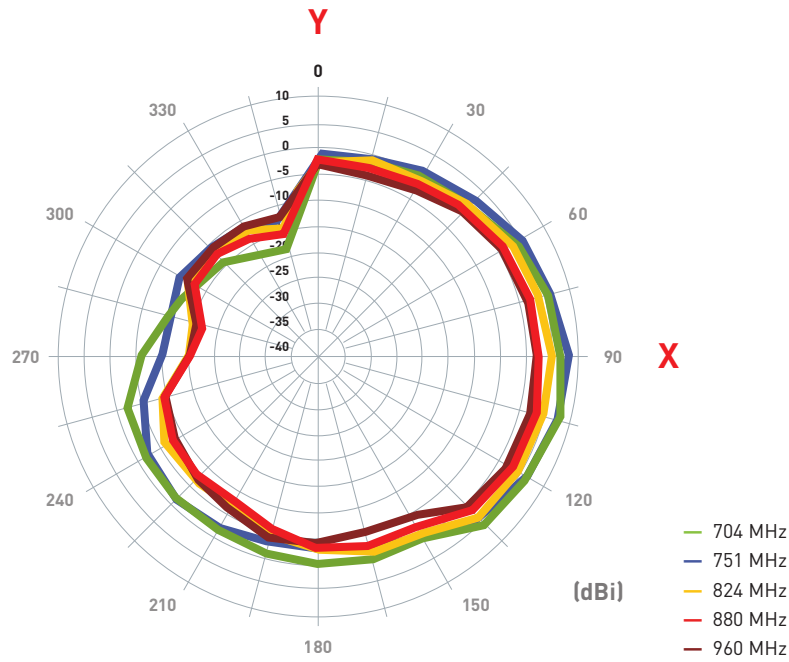

#### XZ Plane

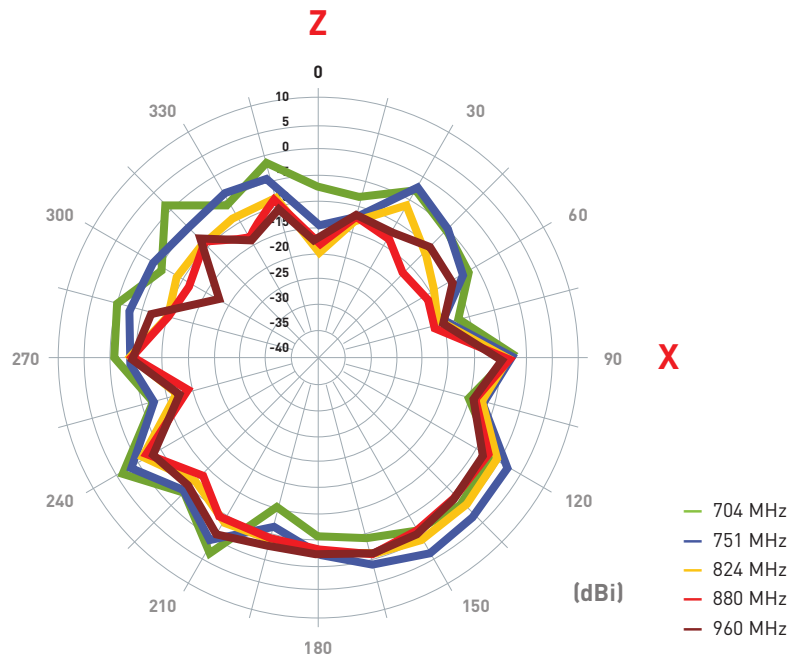

### 4.16.1 Antenna bent 90 with 30x30cm ground plane edge

#### YZ Plane

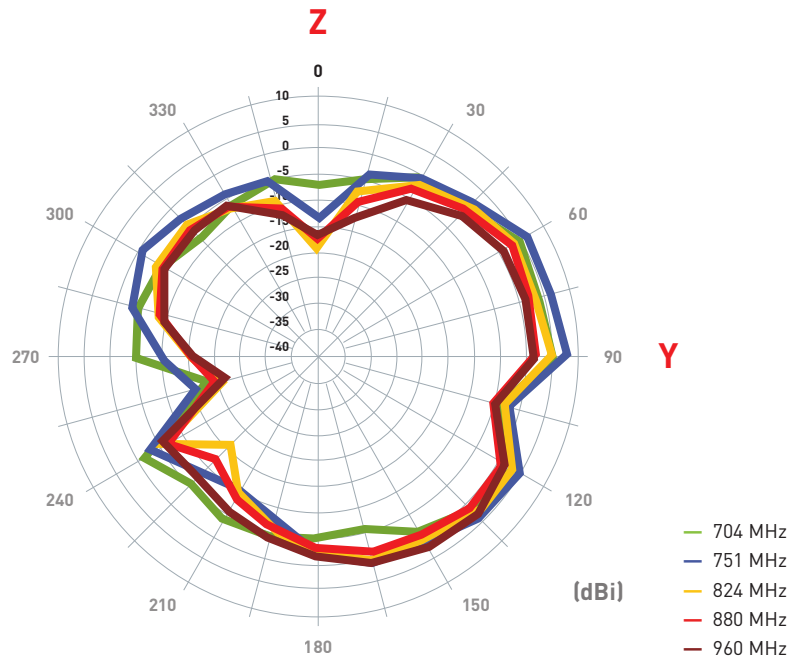

#### XY Plane

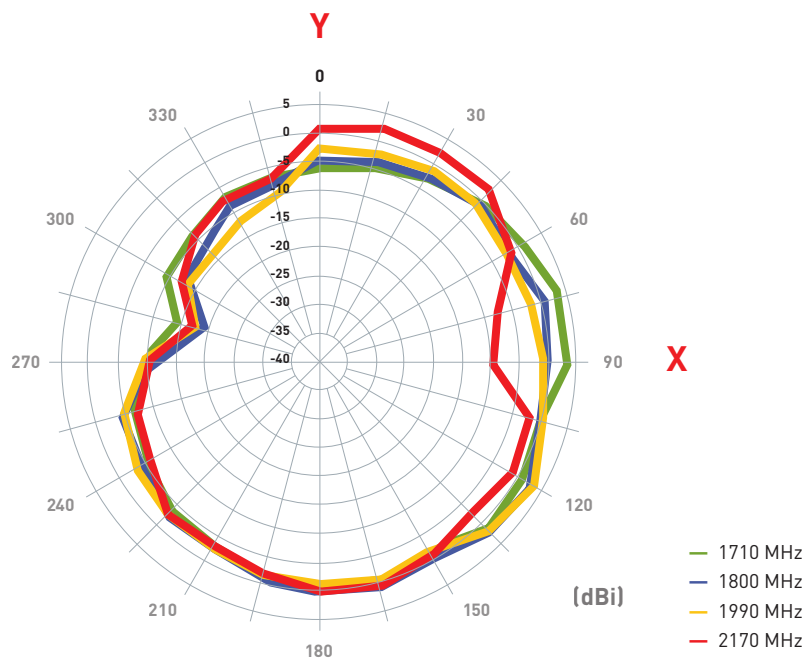

### 4.16.1 Antenna bent 90 with 30x30cm ground plane edge

#### XZ Plane

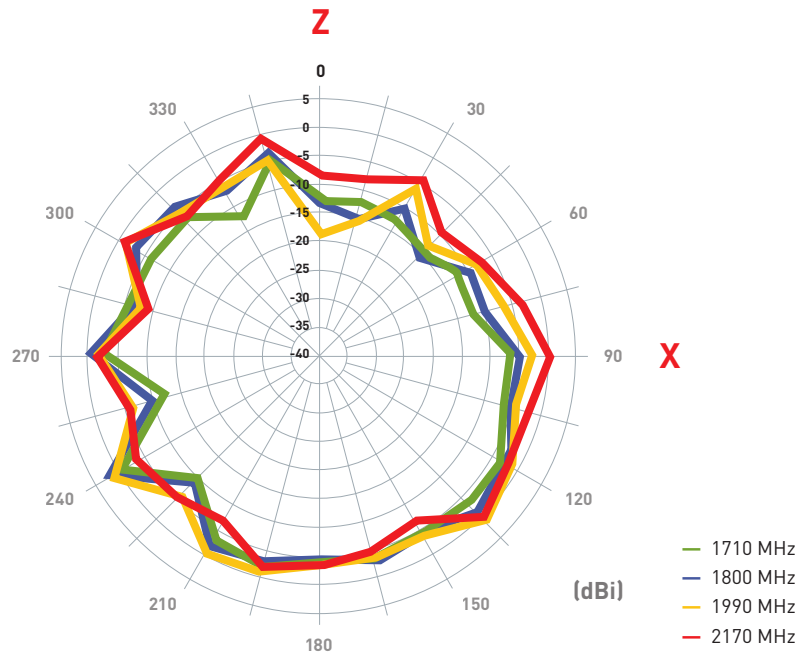

#### YZ Plane

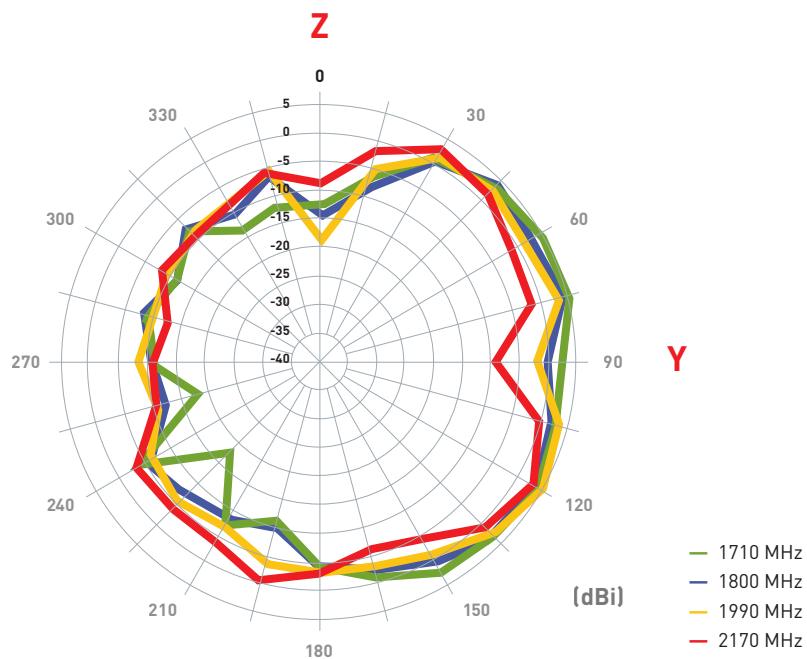

### 4.16.1 Antenna bent 90 with 30x30cm ground plane edge

#### XY Plane

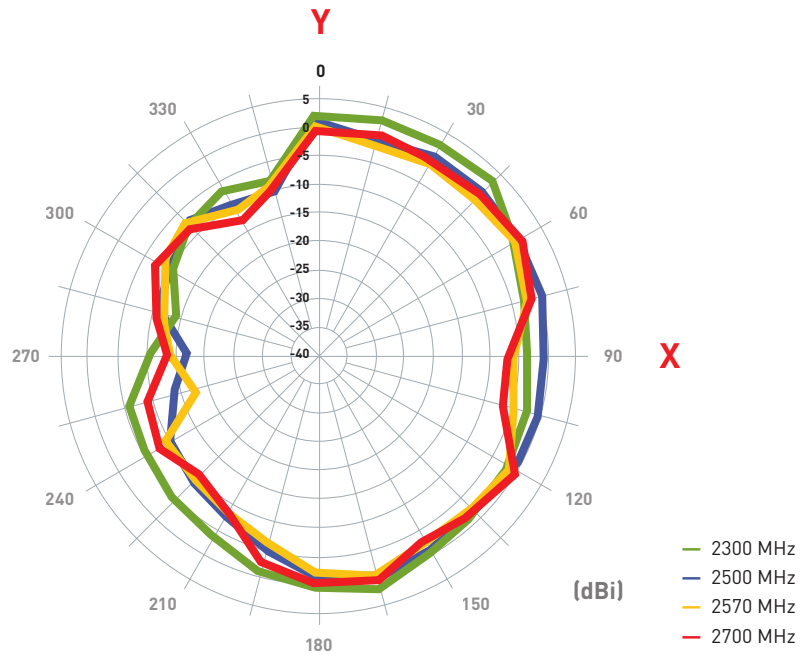

#### XZ Plane

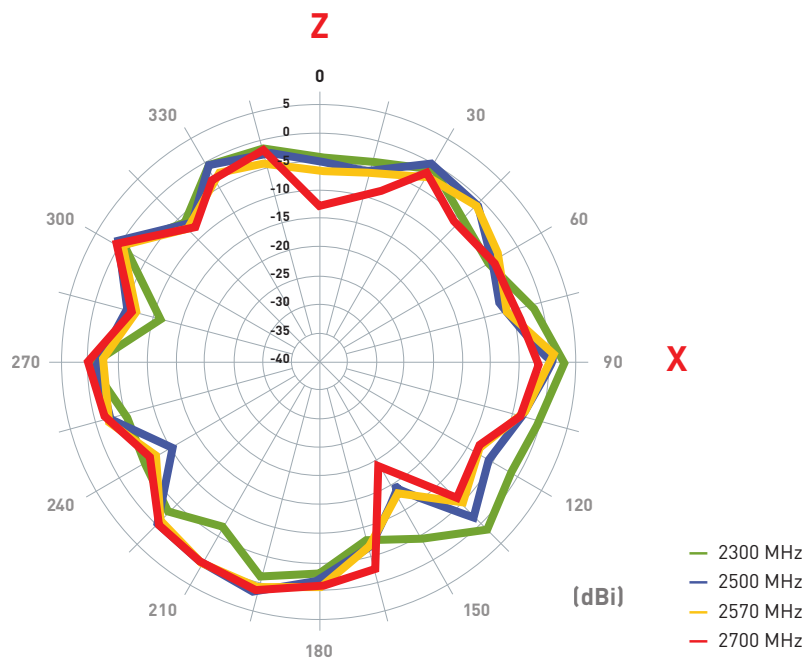



### 4.16.1 Antenna bent 90 with 30x30cm ground plane edge

#### YZ Plane

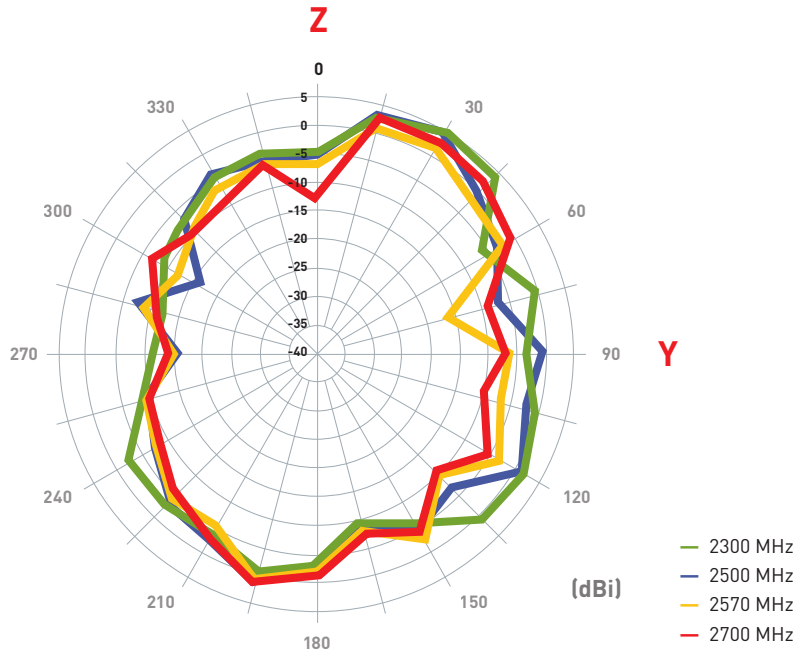

#### XY Plane

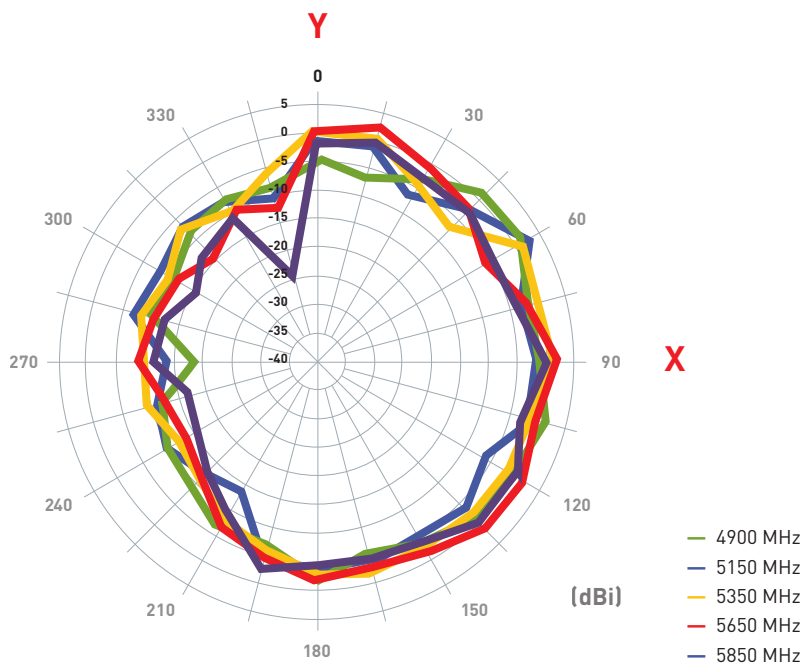

### 4.16.1 Antenna bent 90 with 30x30cm ground plane edge

#### XZ Plane

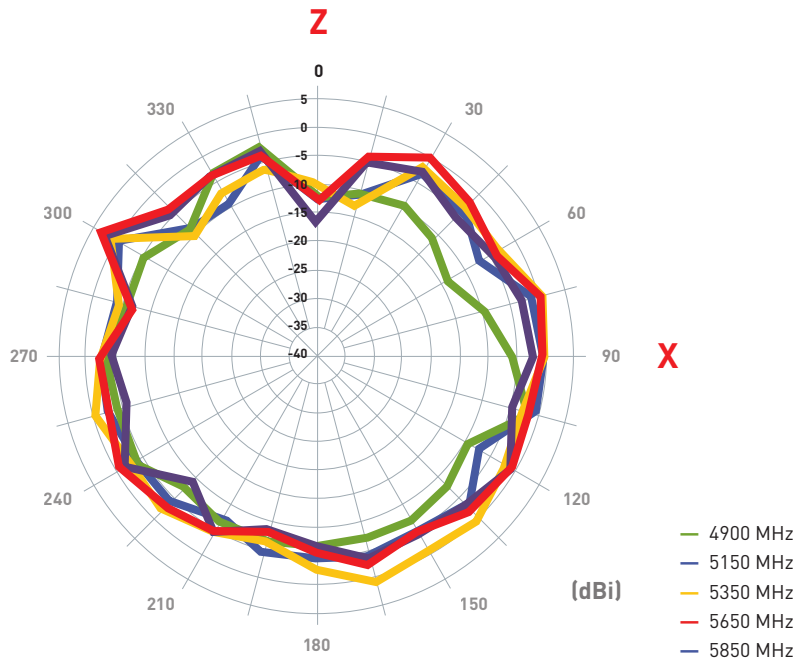

#### YZ Plane

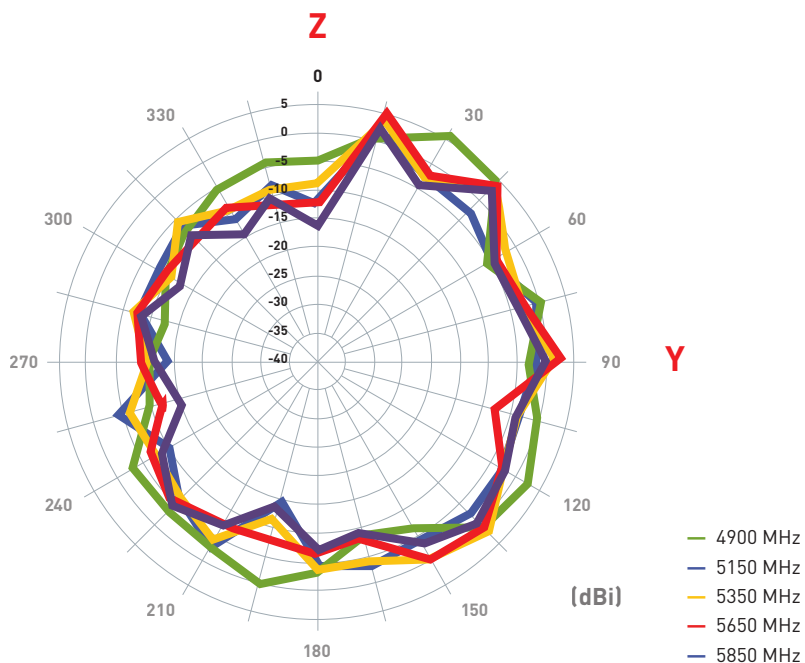

## 5. Installation

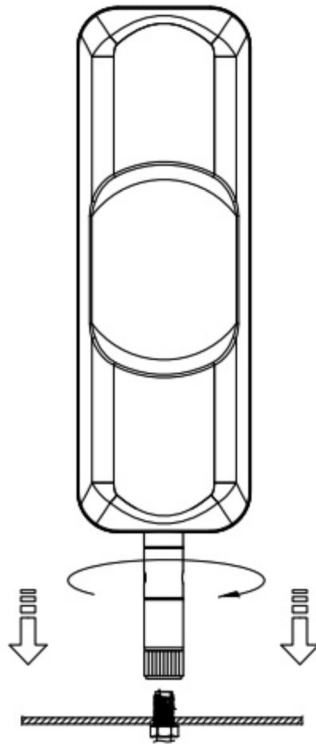

**Recommended torque for mounting is 0.9 N·m**  
**Maximum torque for mounting is 1.176 N·m**

## 6. Drawing

Front View

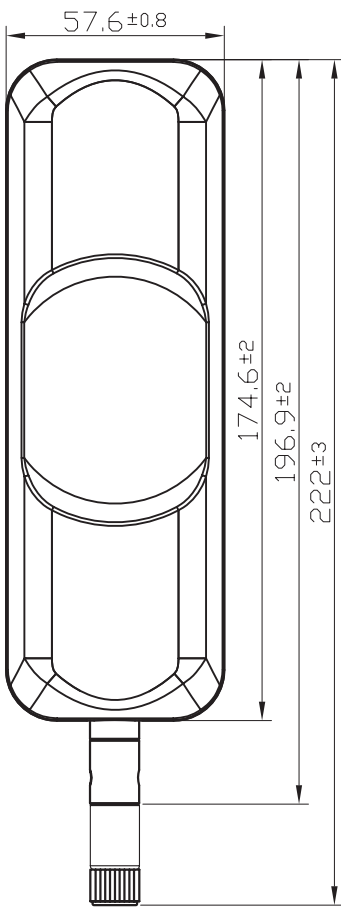

Side View

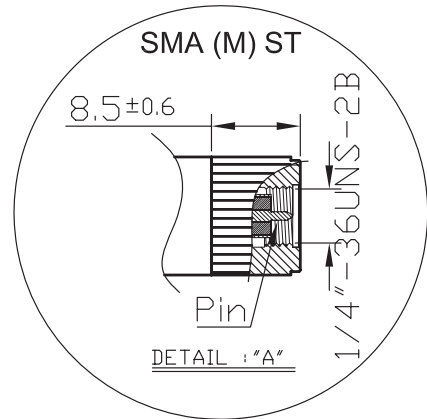
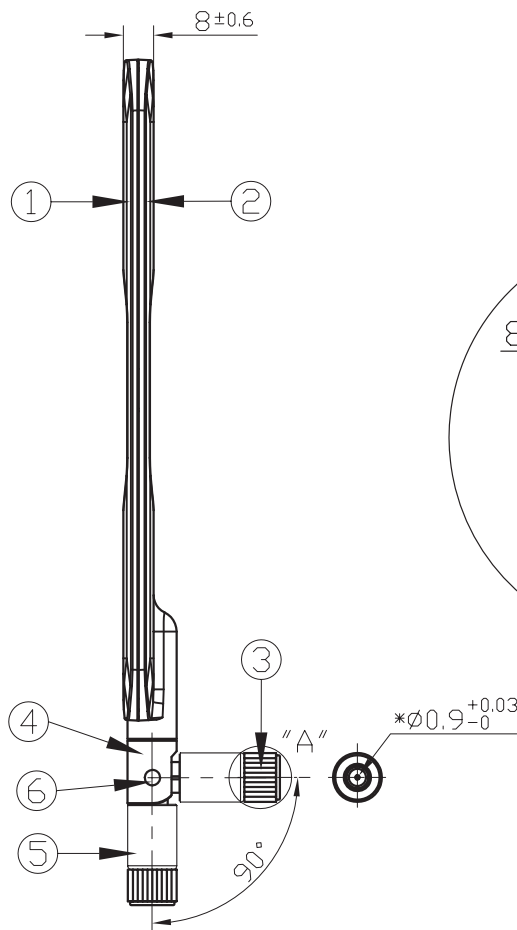

3D View

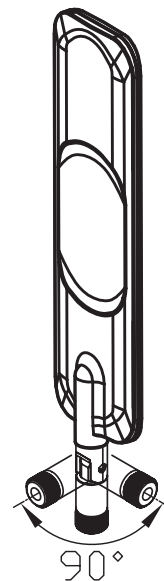

	Name	Material	Finish	Qty
1	Housing Top TG35	ABS	Black	1
2	Housing Bottom TG35	ABS	Black	1
3	SMA(M) ST	Brass	Nickel	1
4	Hinge Top TG35	POM	Black	1
5	Hinge Bottom	ABS	Black	1
6	Rotary Shaft	Brass	Nickel	2

## 7. Packaging

1pc TG.35 per small PE Bag  
75g

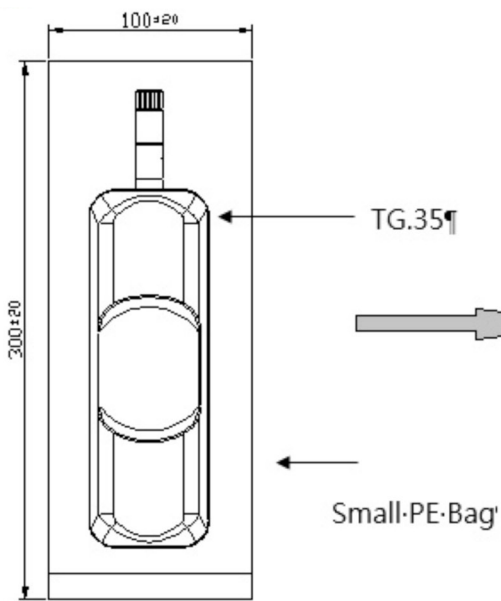

10 small PE bags in 1 large PE bag  
0.75Kg

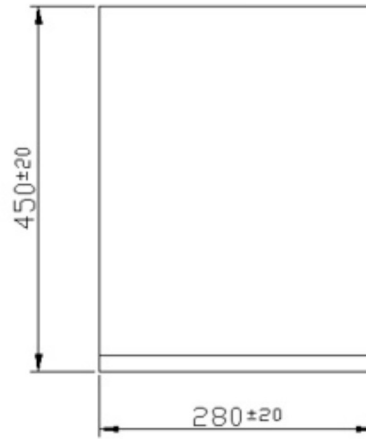

60 Cartons per pallet  
Pallet Dims: 110\*110\*15cm  
6000 pcs per pallet

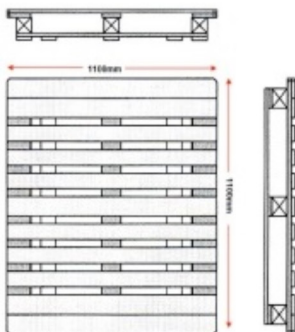

10 Large PE bags per box  
7.9Kg

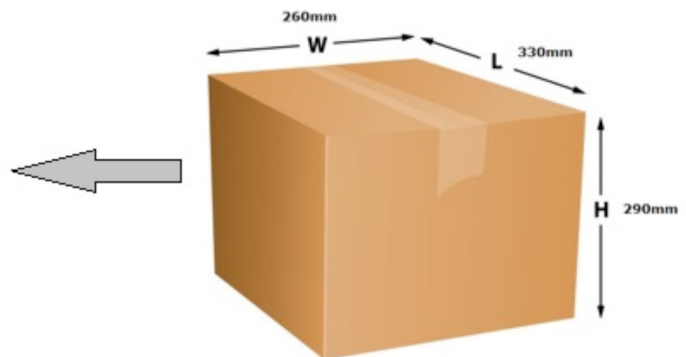

# Mouser Electronics

Authorized Distributor

Click to View Pricing, Inventory, Delivery & Lifecycle Information:

[Taoglas:](#)

[TG.35.8113](#)